

**KOBELT**

PNEUMATIC CONTROLS  
HYDRAULIC STEERING & ACCESSORIES  
ELECTRONIC CONTROLS  
PUSH-PULL CONTROLS  
DISC BRAKES

FOR THE LATEST INFORMATION  
PLEASE VISIT [www.KOBELT.com](http://www.KOBELT.com)

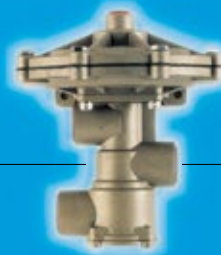

## CONTROL YOUR SHIP WITH COMPLETE SYSTEMS AND COMPONENTS FROM KOBELT MANUFACTURING

- 1 Steering components up to 320 tonmeter for hydraulic steering of single and multi rudder vessels.
- 2 In the aftdeck control station, complete control over all propulsion and deck machinery.
- 3 Hydraulic cylinders and control devices for lowering and raising masts, davits for lifeboats, loading ramps etc.
- 4 Weatherproof controls for outside stations to control propulsion and deck machinery.
- 5 Control components for propulsion and deck machinery, plus electronic alarm systems and electronic telegraphs.
- 6 Control for all deck machinery such as anchor and towing winches.
- 7 Controls for bow thrusters.
- 8 Control components for any propulsion package, fixed pitch CP propellers, load share and load control.
- 9 Propeller shaft disc brakes, from small engines up to 50,000 HP.
- 10 Control components to control stern thrusters.



# WHY ARE KOBELT CONTROLS THE BEST?

## All Kobelt components are made from die cast brass with stainless steel hardware.

- Solid brass frame for watertight installation.
- Stainless steel shaft supported in two bearings.
- Adjustable detents and nylon holding frictions.
- All standard "O"-Rings and "U" Cups.
- Illuminated Sidescales.
- Most stylish, easy, removable solid brass dome.
- Compensating self-relieving regulating valve.
- Light sockets for illumination.
- Dimmer switches if required.
- Mounting screws under the dome.
- Easy installation and maintenance.
- Throttle movement proportional to handle travel.
- Also made for twin engine application.
- All parts interchangeable.
- Available in many configurations and sizes.
- Two-year warranty on all metal parts and synthetic rubber parts.
- Sales and service around the world.

Kobelt pneumatic controls are manufactured under one or more of the following patent numbers. Further patents pending.

U.S. Patent No.	Canadian Patent No.
3455186	828507
3724970	922594
3766835	923767
3783742	928607
3795110	932600
3820438	936055
3826490	939202
3838630	947619
3900090	946138
4522111	964555

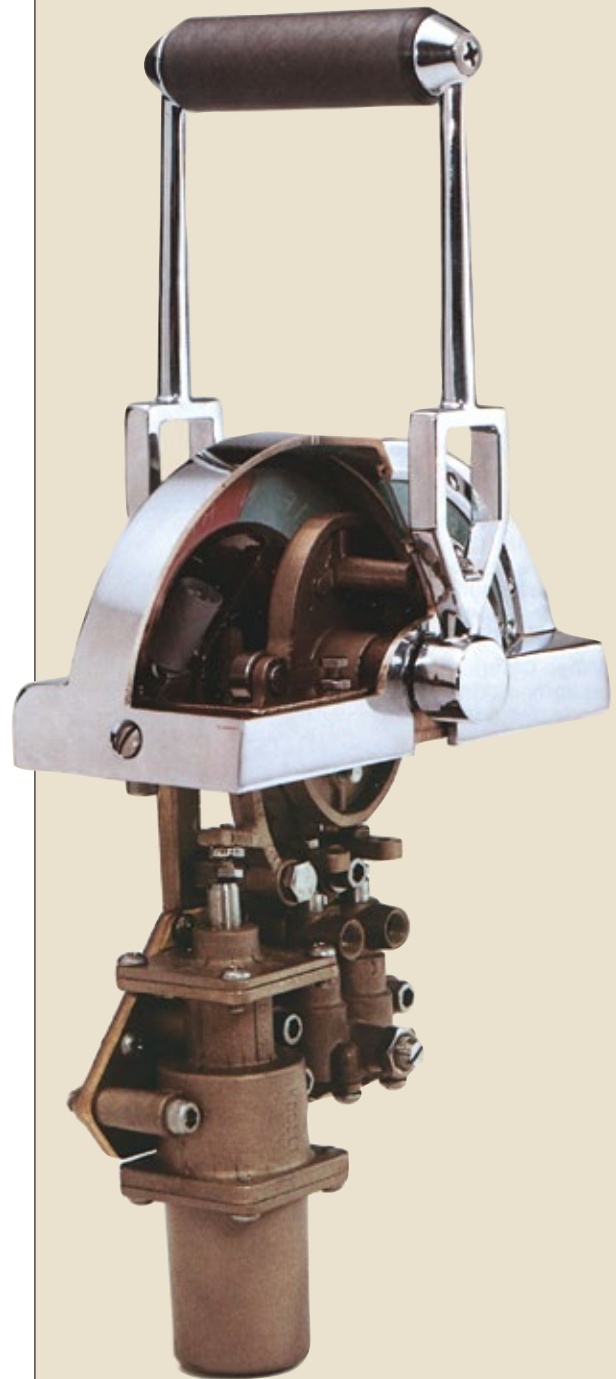

**2554**

Single Lever Clutch & Throttle Pneumatic Control

# STANDARD FEATURES

Our control heads are available in polished brass, chrome plated and black epoxy. When ordering please state finish required. The components are manufactured from non-corrosive die-cast silicon brass with stainless steel hardware.

Illuminated side scales are a standard feature on our 2550 and 2570 series. Optional dimmer switches to regulate the light effect to suit your requirements are available. Only the 2570 series comes with the addition of illuminated top scales. A choice of various handle lengths are available; when ordering please specify.

The dome is removable for easy installation and adjustments. Kobelt has a vast variety of interchangeable components and it is, therefore, very easy for us to produce custom-made control heads, all simply assembled from standard components in various configurations.

## Basic Information on Pneumatic Controls

Kobelt Pneumatic Control components are the most reliable means of control for marine propulsion packages and deck machinery. Our engineering department has done an excellent job in simplifying designs, by eliminating many moving parts and yet retaining all the essential safeguards for propulsion package timing. The simplicity in design, in conjunction with our selection of materials, makes Kobelt the number one choice for Pneumatic Marine Controls.

Pneumatic Marine Controls lend themselves extremely well for multistation remote control, interlocks and time delays, automatic load share and automatic load control.

Kobelt can also provide all necessary alarms, control-consoles and console-tops for your complete turn-key package.

### ORDERING INFORMATION:

#### Letter code designations\*

**When ordering control heads specify model number and letter code designation.**

- A – Left hand
- B – Right hand
- C – One short handle
- D – One long handle
- CD – One short/one long handle
- CC – Two short handles
- DD – Two long handles
- G – Spring return handle with full pressure latching
- H – With chrome finish dome
- J – With polished brass finish dome
- K – With black epoxy finish dome
- L – Sprocket drive
- LL – Double sprocket
- M – Top scale
- N – 0 - 60 PSI
- P – 0 - 80 PSI
- R – 0 - 100 PSI
- S – 0 - 120 PSI
- T – 10 - 60 PSI
- U – 10 - 80 PSI
- W – 10 - 100 PSI
- X – 10 - 120 PSI

Any pressure range is available – please specify when ordering.

### IMPORTANT:

**When ordering from this brochure, model numbers MUST be prefixed. e.g. A-2545**

## Best Today and Still Better Tomorrow!

Kobel products have an enviable reputation for durability and performance. Our success is based on the simple fact that we are the only control manufacturer in the world providing a non-corrosive marine environment control. The absence of plastic, zinc, aluminum and steel, with our rugged design, puts us into an exclusive class in terms of materials and workmanship.

We also manufacture the most complete line of components and systems, with distribution and sales all over the world. If you are not already a Kobelt user please contact your nearest distributor for the whole story.

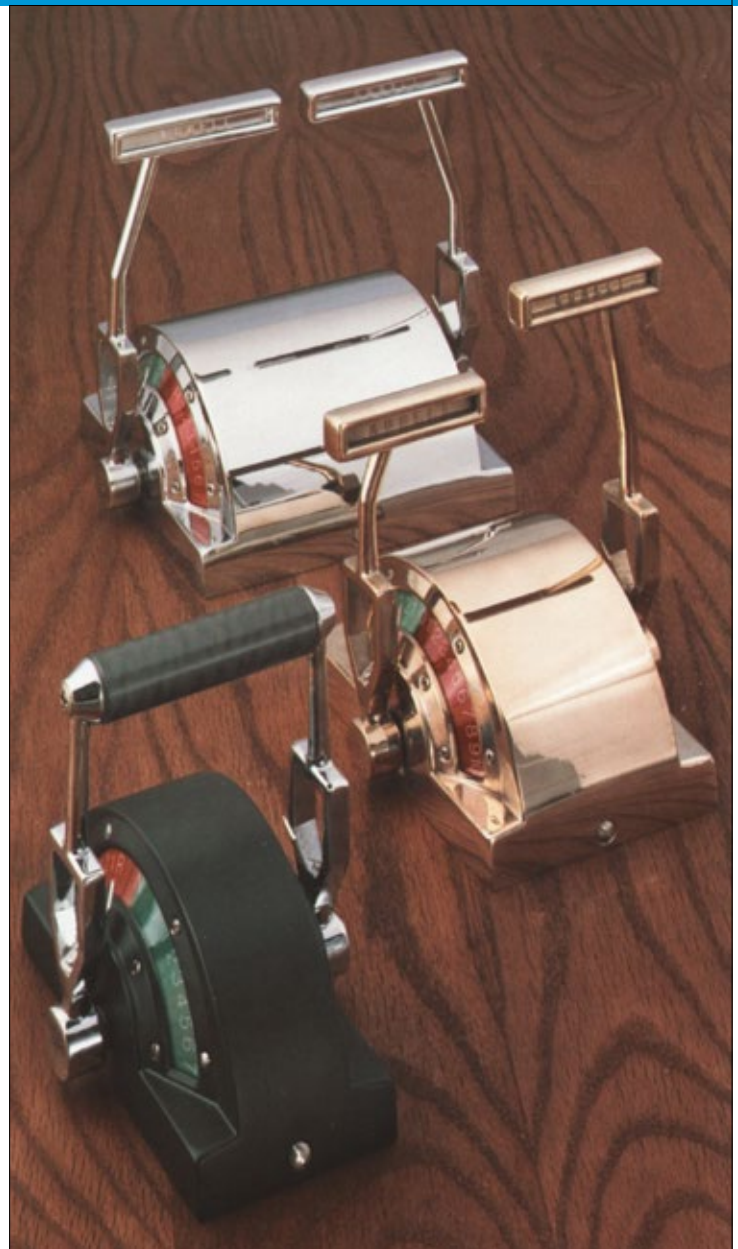

*The Pandora was built approximately 30 years ago with Kobelt 5-station air controls and is still going strong!*



# DUAL FUNCTION CONTROL HEAD 1/8" NPT

## MODELS 2544 and 2554

These two control heads are designed to provide single lever control over ship direction (ahead and astern) and engine speed. The pneumatic signal for ahead and astern can control either a hydraulic reduction gear or a pneumatic actuating gear. These controls can also be used for the control of direct reversing engines. The pipe connections are all 1/8" NPT. The control is intended for vessels ranging from 40 to 175 feet (12m to 55m) in length. It can be provided for big vessels on short tubing runs from the wheelhouse or in the engine room.

The Model 2544 has a standard dome and handle (no illumination). Model 2554 is equipped with side scales and internal light sockets for illumination. Except for the dome and handle, all parts are interchangeable. Dimensionally, the control heads are the same.

**NOTE:** Right-hand model standard. If left-hand model for 2544 is required, reverse indicator label.

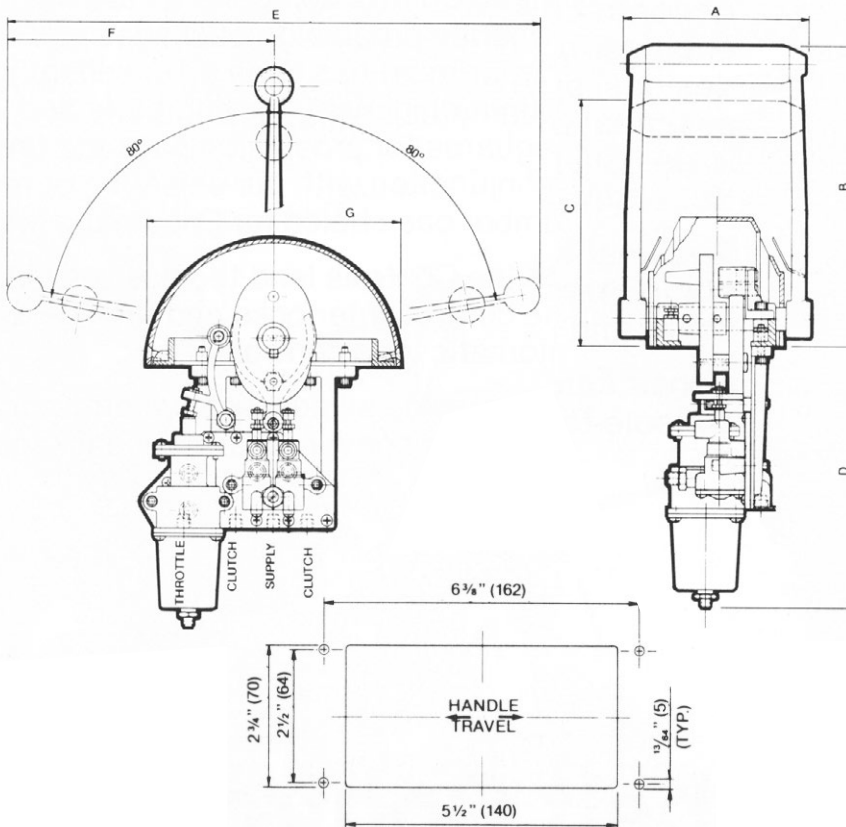

SCHEMATIC SYMBOL

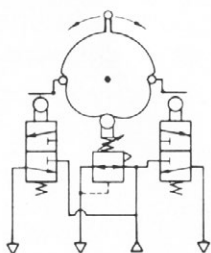

"CUT-OUT" DIMENSIONS  
OUTPUT PRESSURE VS LEVER TRAVEL

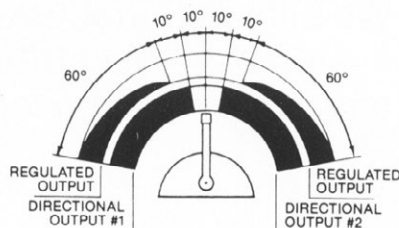

	A	B	C	D	E	F	G
MODEL 2544	4 1/8 (105)	8 3/4 (222)	7 1/2 (190)	7 7/8 (200)	15 3/4 (400)	7 7/8 (200)	7 1/4 (184)
MODEL 2554	4 7/8 (124)	8 1/4 (210)	6 3/4 (171)	7 7/8 (200)	14 3/4 (374)	7 3/8 (187)	7 (178)

**Weight:** 9 lbs (4 kg)

**Maximum Supply Pressure:** 150 PSI (10.3 BAR)

**Operating Temperature Range:** -40°C to +90°C

**Pipe Port Size:** 1/8" NPT

**Letter code designations:\***

C, D, E, H, J, K, N, P, R, S, T, U, W, X

Short handle standard for Model 2544  
and long handle standard for Model 2554.

\* refer to page 2 for letter code designation table

# TWIN DUAL-FUNCTION CONTROL HEAD 1/8" NPT

## MODELS 2545 and 2555

The control heads illustrated are Models 2545 and 2555, designed for twin engine, single lever clutch and throttle control. These controls have been used by hundreds of boat owners, around the world, who are totally satisfied with our control systems.

Model 2555, which is a recent development, is the most stylish looking control head. It is made of all-brass and stainless steel construction with side scales for illumination. This product, in fact, has been so well received by the bigger pleasure craft industry that most cruisers now being constructed are equipped with Model 2555 because of its good looks and dependability. The valve used for controlling the clutch is Model 3803 and the valve controlling the throttle is Model 3217. These valves are standard on all our 1/8" NPT series heads.

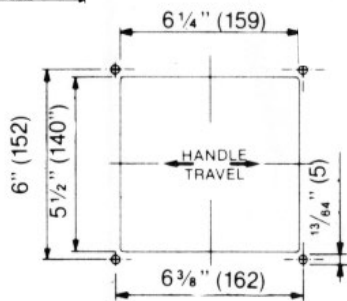
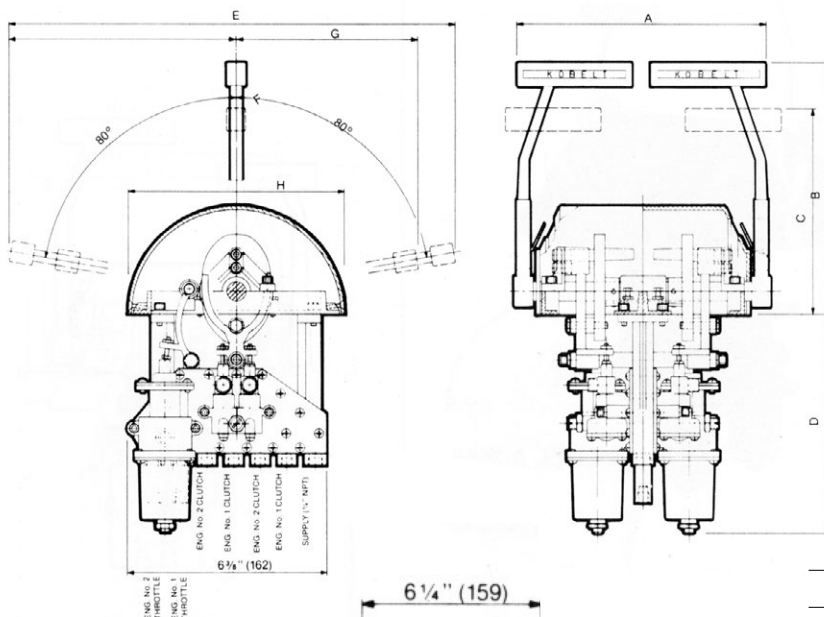
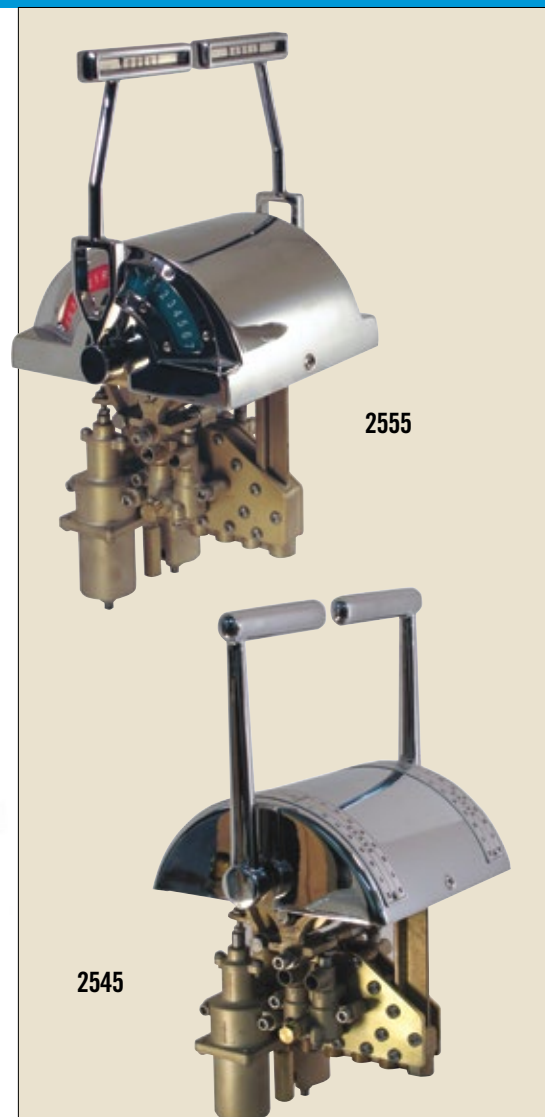

"CUT-OUT" DIMENSIONS

	A	B	C	D	E	F	G	H
MODEL 2545	8 5/8 (219)	8 7/8 (225)	7 3/8 (187)	7 1/4 (184)	15 3/4 (400)	7 7/8 (200)	6 1/2 (165)	7 1/8 (181)
MODEL 2555	8 1/2 (216)	7 3/8 (187)	6 3/4 (172)	7 1/4 (184)	14 1/2 (368)	7 1/4 (184)	6 (152)	7 (178)

**Weight:** 20 lbs (9 kg)

**Maximum Supply Pressure:** 150 PSI (10.3 BAR)

**Operating Temperature Range:** -40°C to + 90°C

**Pipe Port Sizes:** *Input:* 1/4" NPT *Output:* 1/8" NPT

**Letter code designations:\***

CC, DD, E, H, J, K, N, P, R, S, T, U, W, X

Short handle standard for Model 2545  
and long handle standard for Model 2555.

\* refer to page 2 for letter code designation table

SCHEMATIC SYMBOL

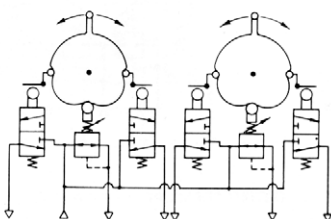

OUTPUT PRESSURE VS LEVER TRAVEL

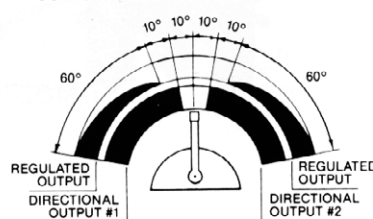

# PRESSURE CONTROL HEADS

## 2 Lever – Triple Output 1/8" NPT

### MODELS 2546 and 2556

These control heads were designed to provide control for controllable pitch propeller and engine speed. The long handle (pitch) actuates two pressure regulating valves which provide "0" pressure for "0" pitch. In case of air pressure failure, the C.P. propeller actuator will return to "0" pitch position. The engine speed control (short handle) will provide accurate control over the engine speed. Loss of air pressure again will cause the engine to return to idle.

Model 2546 is equipped with a standard dome. Model 2556 is equipped with side scales for illumination. Both control heads can also be used for the control of the Omega twin disc gear.

Control packages are available to fit the twin Disc Omega gear, and standard C.P. control actuators can be adapted to any C.P. propeller.

	A	B	C	D	E	F	G	H
MODEL 2546	8 3/4 (222)	8 3/4 (222)	7 3/8 (187)	6 3/4 (171)	14 1/2 (368)	7 1/4 (184)	5 3/4 (146)	7 1/2 (191)
MODEL 2554	8 7/8 (225)	8 1/4 (210)	6 3/4 (171)	6 3/4 (171)	14 (356)	7 (178)	5 5/8 (143)	7 (178)

**Weight:** 13.5 lbs (6 kg)

**Maximum Supply Pressure:** 150 PSI (10.3 BAR)

**Operating Temperature Range:** -40°C to +90°C

**Pipe Port Size:** 1/8" NPT

**Letter code designations:\***

A, B, CC, DD, CD, E, F, FF, H, J, K, N, P, R, S, T, U, W, X



2546

2556

#### SCHEMATIC SYMBOL

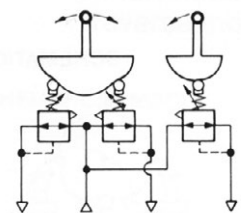

Movement of Handle in Direction of Arrow Increases Output Pressure

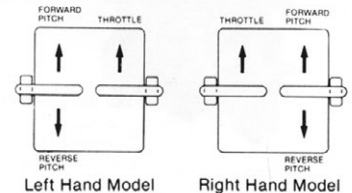

#### OUTPUT PRESSURE vs LEVER TRAVEL

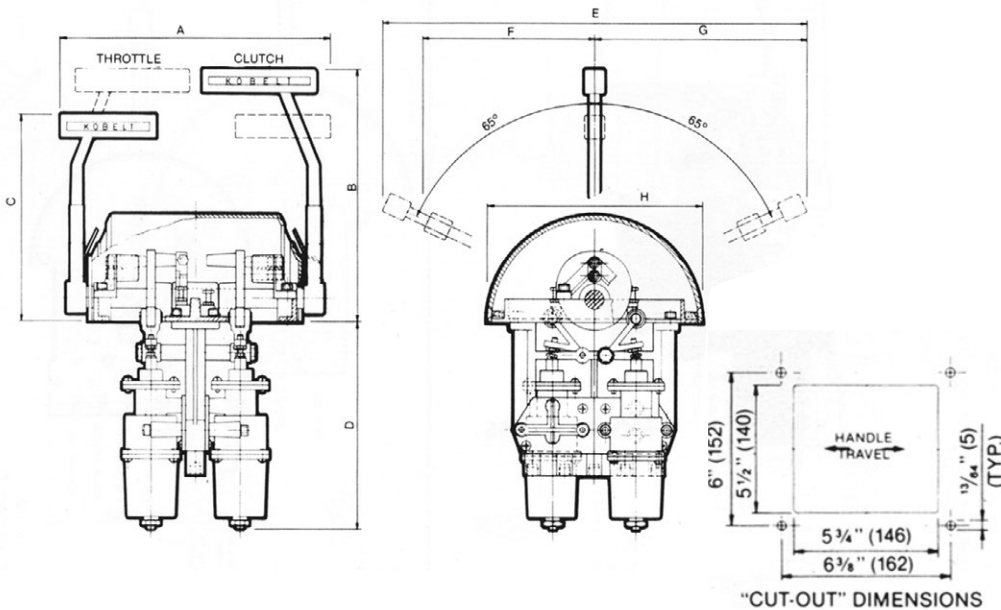
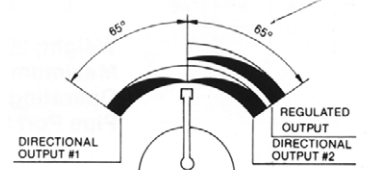

\* refer to page 2 for letter code designation table



## 2 Lever – Four Outputs 1/8" NPT

### MODELS 2547 and 2557

These control heads are equipped with four compensating regulating valves to provide infinite pressure – increase in either direction for both handles. It, therefore, lends itself ideally for the control of two C.P. propellers. This control head can also be used for twin engine, single lever control for C.P. propeller and engine speed. Special actuators will be required to accomplish this task. Please consult Kobelt or your nearest distributor. These units are manufactured in all brass and stainless steel, just like all other Kobelt control heads, and provide years of trouble-free service.

The Model 2547 has a standard dome and Model 2557 has side scales for illumination. Both controls have the same physical dimensions and use the same parts, except for dome and handle.

	A	B	C	D	E	F	G
MODEL 2545	8 7/8 (225)	8 3/4 (222)	7 3/8 (187)	6 7/8 (175)	7 1/4 (184)	14 1/2 (368)	7 1/4 (184)
MODEL 2555	8 3/8 (213)	8 1/4 (210)	6 3/4 (172)	6 7/8 (175)	6 15/16 (176)	13 7/8 (352)	7 (178)

**Weight:** 15 lbs (7 kg)

**Maximum Supply Pressure:** 150 PSI (10.3 BAR)

**Operating Temperature Range:** -40°C to +90°C

**Pipe Port Size:** 1/8" NPT

**Letter code designations:\***

CC, DD, CD, E, H, J, K, N, P, R, S, T, U, W, X

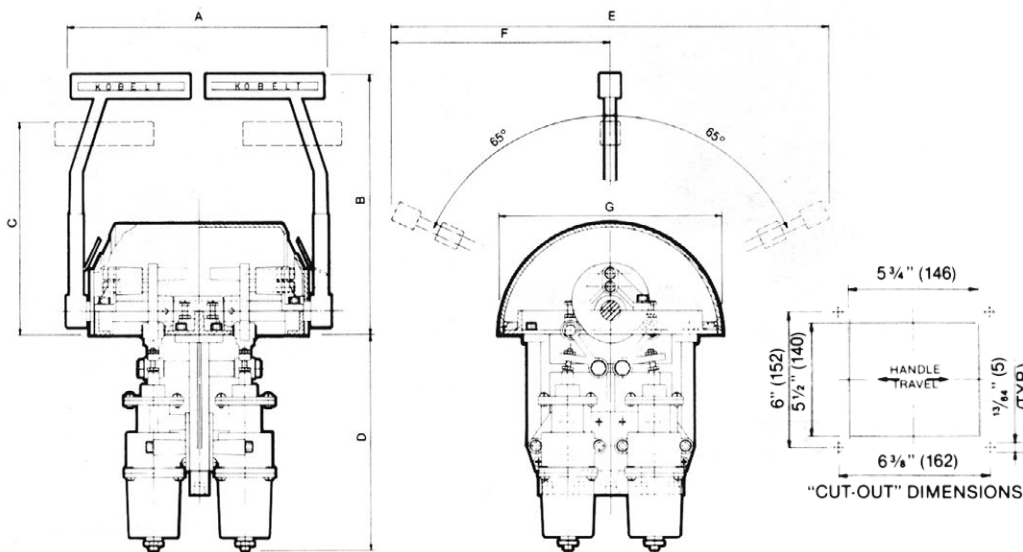

SCHEMATIC SYMBOL

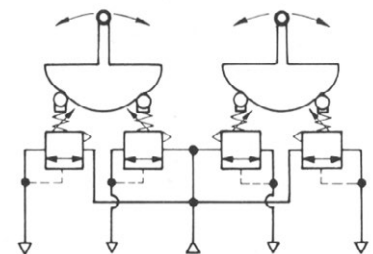

OUTPUT PRESSURE vs LEVER TRAVEL

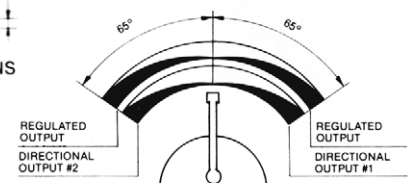

\* refer to page 2 for letter code designation table

# DUAL FUNCTION CONTROL HEAD 1/8" NPT

## MODELS 2534 and 2535

Both controls are designed to be interconnected mechanically with Kobelt Wire-Over-Pulley Controls and, therefore, eliminate the necessity of station transfer. All handles connected in such a system will move together. This has proven extremely successful in very cold weather conditions, whereby the outside stations are mechanically interconnected to the wheelhouse pneumatic station, therefore eliminating freezing in airlines to bridge wings.

NOTE: Right-hand model standard. If left-hand model for 2534 is required, reverse indicator label.

**Weight:** 11.5 lbs (5kg)

**Maximum Supply Pressure:** 150 PSI (10.3 BAR)

**Operating Temperature Range:** - 40°C to +90°C

**Pipe Port Size:** 1/8" NPT

### Letter code designations:\*

C, D, H, J, K, N, P, R, S, T, U, W, X

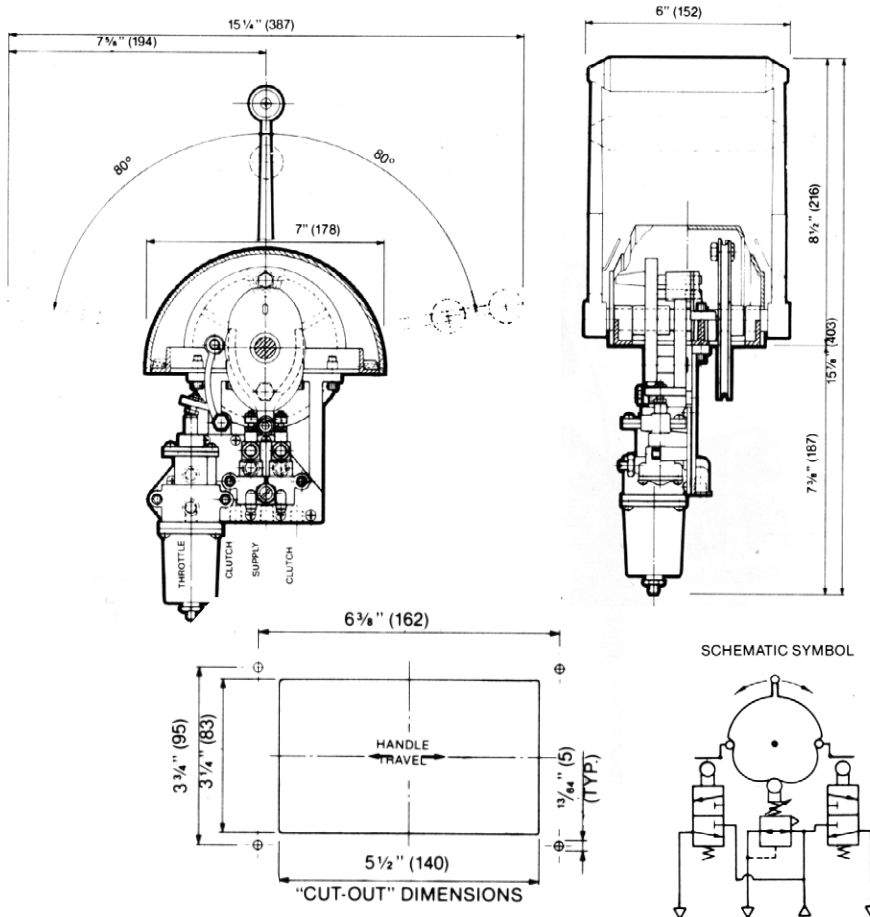

\* refer to page 2 for letter code designation table



### Two Station Control

Pneumatic Control Head  
(Master Station)

Mechanical Control Head  
(Slave Station)

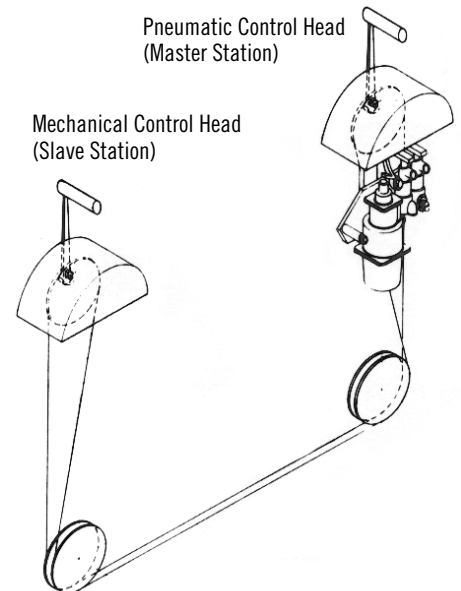

# MECHANICAL & ELECTRICAL REMOTE CONTROL HEADS

## Single Handle – MODEL 2570-1

## Twin Handle – MODEL 2570-2

These control heads were designed with the big ship owner in mind. They incorporate the many Kobelt design innovations making them durable, non-corrosive and attractive. Many control requirements can be accomplished with these units. They are available for purely mechanical drive or electric applications with potentiometers and micro switches. A mixture of mechanical, electric and pneumatic applications are available. Please consult us for your specific requirements.

Model 2570-1 is intended for the control of one engine.

Model 2570-2 can be used for a twin engine control.

### Letter code designations:\*

Model 2570-1 – H, J, K, L, LL, M

Model 2570-2 – CC, DD, CD, H, J, K, L, M

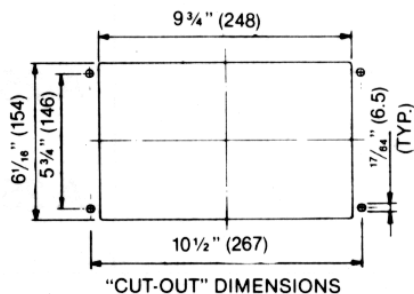
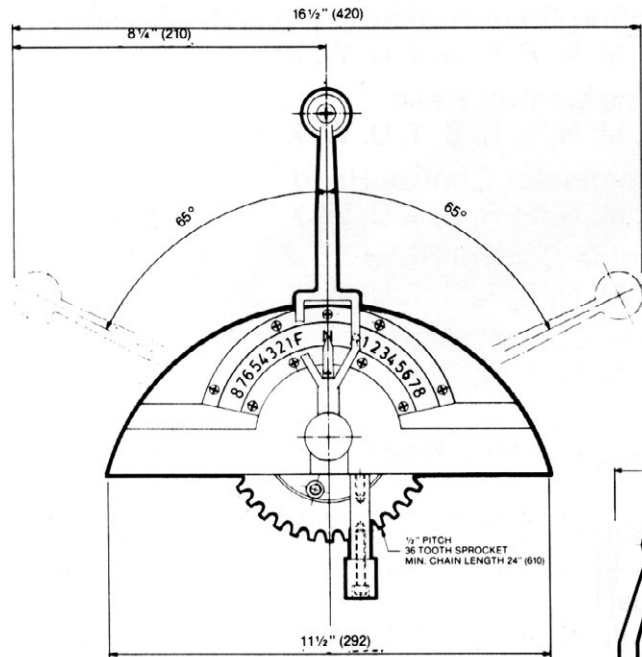

"CUT-OUT" DIMENSIONS

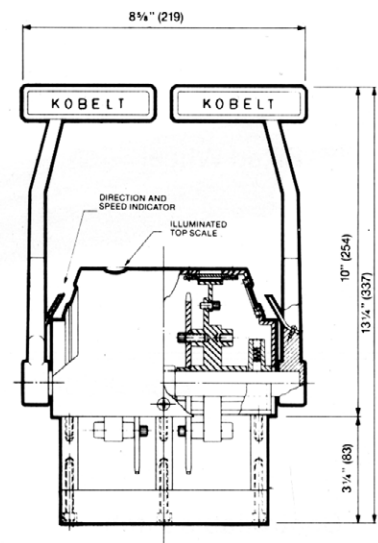
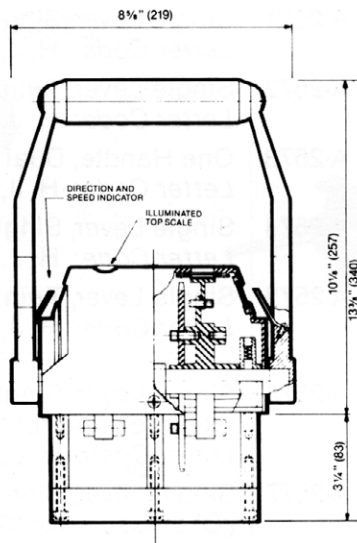

2570-1



2570-2



Weight approx. 17 lbs. (8kg)

\* refer to page 2 for letter code designation table

## 2570 SERIES

An enormous variety of standard 2570 series pneumatic control heads are available to accomplish any control function desired. The most advanced production technology (die cast brass), as well as the latest design concepts, combined with the rugged, yet stylish appearance makes the 2570 series control heads the finest of their kind. A variety of standard mechanical adjustable cams are available.

As mentioned on the foregoing page, custom made control heads are available and we have provided enumerable customer specified products. All pneumatic 2570 series control heads are equipped with a combination of 3804 four-way valves and 3230 pressure compensating valves. The table below indicates the standard pneumatic control heads available.

Application	Model	Description
Fixed Wheel	2571	Single Lever, Single Engine Control Head <i>Letter Code: H, J, K, L, M, N, P, R, S, T, U, W, X</i>
	2572	Single Lever, Twin Engine Control Head <i>Letter Code: H, J, K, L, M, N, P, R, S, T, U, W, X</i>
	2573	One Handle, Dual Compensator Control Head <i>Letter Code: H, J, K, L, M, N, P, R, S, T, U, W, X</i>
	2574	Single Lever, Single Engine Control Head <i>Letter Code: H, J, K, L, M, N, P, R, S, T, U, W, X</i>
	2575	Single Lever, Twin Engine Control Head <i>Letter Code: H, J, K, L, M, N, P, R, S, T, U, W, X</i>
Controllable Pitch	2576	Single Lever, Single Engine Control Head (Mid-pressure for '0' pitch) <i>Letter Code: H, J, K, L, M, N, P, R, S, T, U, W, X</i>
	2577	Single Lever, Single Engine Control Head ('0' pressure for '0' pitch) <i>Letter Code: H, J, K, L, M, N, P, R, S, T, U, W, X</i>
	2578	Two Handle, Single Engine Control Head <i>Letter Code: A, B, H, J, K, L, M, N, P, R, S, T, U, W, X</i>
	2579	Single Lever, Twin Engine Control Head <i>Letter Code: H, J, K, L, M, N, P, R, S, T, U, W, X</i>

Note: If sprockets are required, top scales are not available for models 2572, 2573, 2575, 2576, 2577, 2578 and 2579.



# DOUBLE-ACTING SELF-CENTERING ACTUATORS

## MODELS 4204 and 4207

These units actuate hydraulically and mechanically actuated reverse reduction gear boxes. They are spring-centered requiring only two control lines for engaging either forward or reverse clutch.

### MODEL 4204

Letter code designations:

A – Two-Direction Position Actuator 10-80 PSI

C – Three-Position Self-Centering Cylinder 35-65 PSI

### MODEL 4207

Letter code designations:

A – Two-Direction Position Actuator 10-80 PSI

C – Three-Position Self-Centering Cylinder 25-55 PSI

MODEL	4204	4207
Max. Input Pressure	200 PSI (13.8 BAR)	
Operating Temp. Range	- 40°C to +90°C	
Port Size	1/4" NPT	
Max. Total Stroke (Approx.) mm	2" (50)	4 3/4" (120)



4204

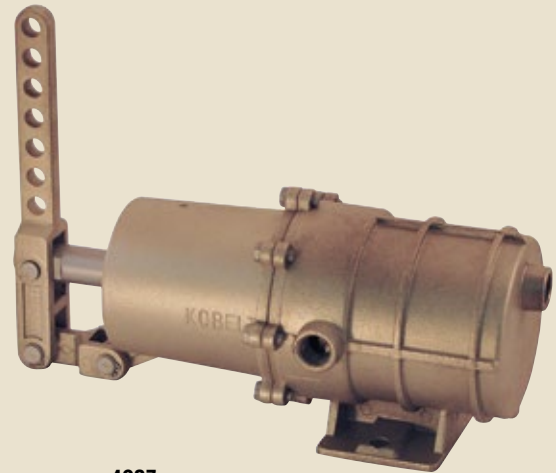

4207

# THROTTLE ACTUATORS & POSITIONERS (Single Direction)

Illustrated are three of the most popular throttle actuators, available from stock. The 4107 and 4108 are equipped with rolling diaphragms to provide the ultimate in accuracy. All units are made in brass and stainless steel with carbon steel spring. Model 4105 is intended for light duty use and is equipped with a maximum speed stop and idling stop. The Model 4107 is a medium duty unit and has a manual overriding control allowing engine speed setting without air pressure. The output rod is infinitely adjustable with the double lock nuts. The Model 4108 is intended for heavy duty use. The large bore actuator produces enough force to control even the most difficult throttle and governor levers. Its rugged design makes it an outstanding performer where accuracy is required. The output rod is again adjustable, by moving it up or down, to obtain the precise stroke required.

## MODEL 4105

Letter code designations:

U - 10-80 PSI input pressure range

R - 0-100 PSI input pressure range

Other ranges available on request.

## MODEL 4107

Letter code designations:

U - 10-80 PSI input pressure range

R - 0-100 PSI input pressure range

Other ranges available on request.

## MODEL 4108

Letter code designations:

U - 10-80 PSI input pressure range

R - 0-100 PSI input pressure range

Other ranges available upon request.

MODEL	4105	4107	4108
Max. Input Pressure	200 PSI (13.8 BAR)		
Operating Temp. Range	- 40°C to +90°C		
Pipe Port Size	1/4" NPT		
Max. Total Stroke (Approx.) mm	2 3/8" (60)	3 1/2" (89)	4 3/16" (106)
Stroke as Linear Actuator	5/8" (16)	1" (25)	—



4105

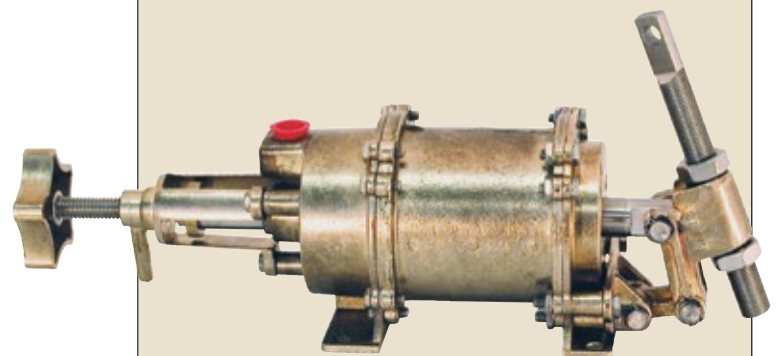

4107

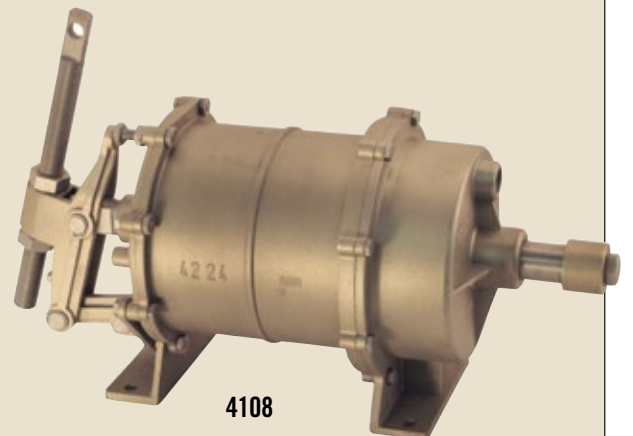

4108

# STATION TRANSFER

On multi-station remote controls it is necessary to transfer the command from one station to another. Kobelt provides all components required to accomplish this task. The inspection authorities have different view points regarding the transfer of pneumatic stations. Kobelt, however, can comply with all of these requests. Illustrated on this page are a few of the items required in the transfer of stations.

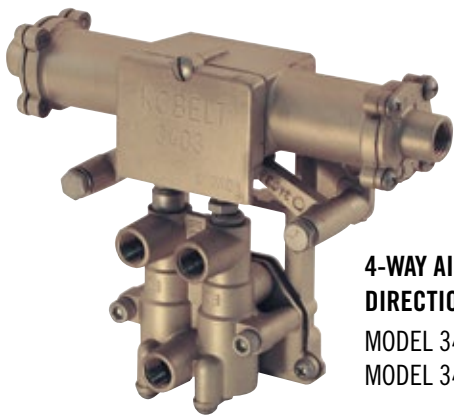
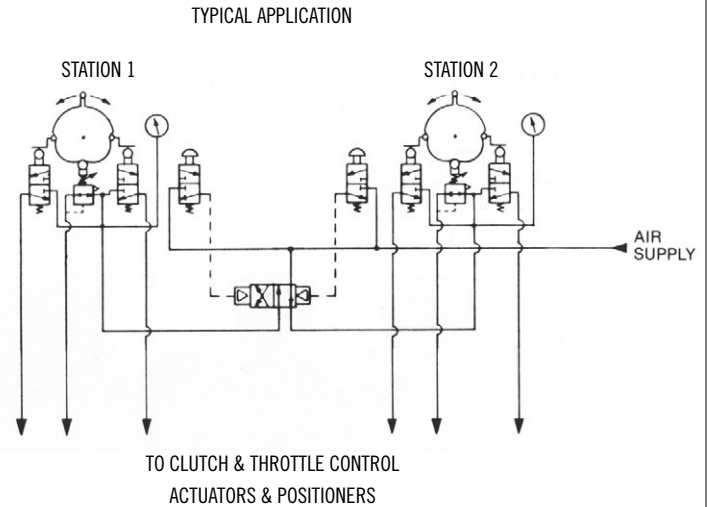

**4-WAY AIR PILOT  
DIRECTIONAL CONTROL VALVE**  
MODEL 3403 (1/4" NPT)  
MODEL 3405 (1/2" NPT), *not shown*

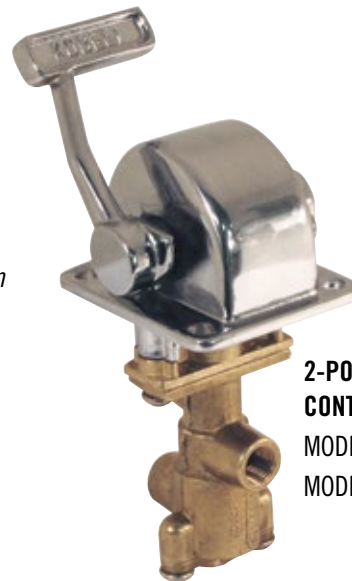

**2-POSITION, 3 WAY  
CONTROL VALVE (1/8" NPT)**  
MODEL 3514 (1/8" NPT)  
MODEL 3515, (1/4" NPT), *not shown*



**SINGLE HANDLE  
4-WAY DIRECTIONAL  
CONTROL HEAD**  
MODEL 3609 (1/4" NPT)  
MODEL 3604 (1/8" NPT), *not shown*

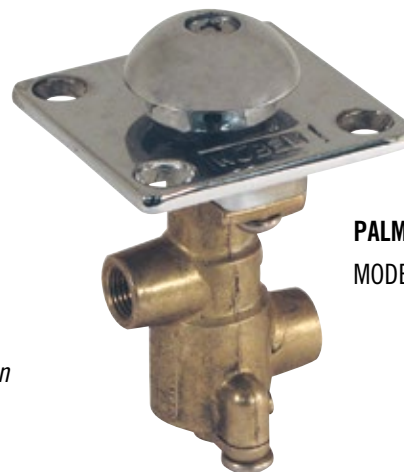

**PALM VALVE**  
MODEL 3517 (1/8" NPT)

# PRESSURE CONTROL HEADS

## MODELS 2542 and 2543

These control heads consist of a lever-cam operated, accurate, self-relieving regulating valve. Handle movement actuates the regulating valve, delivering output pressure according to handle position.

The 2543 unit consists of two levers for dual output. With the handle in the centre or "off" position, both outputs are at zero or lowest pressure. Movement of the handle in either direction delivers regulated pressure to the chosen output according to handle position. The other output remains vented to atmosphere.

**Weight:** Model 2542 - 6.3 lbs (2.9 kg)/ Model 2543 - 10 lbs (4.5 kg)

**Materials:** Die cast silicon brass and stainless steel hardware.

**Maximum Supply Pressure:** Model 2542 - 150 PSI (10.3 bar)/  
Model 2543 - 150 PSI (10.3 bar)

**Operating Temperature Range:** -40°C to +90°C

**Pipe Port Size:** 1/8" N.P.T.

*The standard model 2542 Control Head is supplied as follows:*

- I. Left hand model with short handle
- II. Handle with adjustable holding friction
- III. With chrome finish cover and handle
- IV. In any standard pressure range

*The standard model 2543 Control Head is supplied as follows:*

- I. Handle with centre detent and adjustable holding friction
- II. With chrome finish cover and handle
- III. In any standard pressure range





# DRILLER VALVE

## MODEL 2588

Model 2588, constructed entirely in durable bronze and stainless steel, is suited for land and offshore applications, even corrosive salt water environments. It is available in various pressure ratings, but is usually recommended at 0 to 100-120 PSI maximum.

The cam on the brake valve is removable and can be modified to provide special pressure profiles. Some operators prefer to have a gradual pressure increase on the low end, especially working with a light rig load, and a more rapid pressure increase for heavier loads. The Driller Valve is extremely responsive to its handle movement and can be graduated within 1 PSI in pressure change. This is extremely important as good feel and response is a must. It is important, however, to remember that the 2588 model cannot be plumbed into the brake directly. A pressure compensated relay valve such as Model 3329 (see below) is required to increase the flow to the brake itself.



2588

# PILOT OPERATED PRESSURE COMPENSATING RELAY VALVE

## MODEL 3329

The purpose of this relay valve is to provide a large volume of air to clutches, brakes or cylinders with a small pilot control. The 3329 is a very accurate control valve and provides 5/8" full air flow. The pilot line can be controlled from multiple stations.

This unit has an upper and lower chamber. The upper chamber can receive a variable control pressure. The diaphragm is depressed downward and the air supply from the main source can flow from the in-port to the out-port. In the process of generating pressure in the out-port, a small passage (balancing line) is provided that sends the same air pressure that is going to the out-port into the underside of the diaphragm chamber. Therefore, the outlet pressure to the main cylinders or brakes will always be equal to the pilot pressure since the diaphragm will settle at equilibrium where the pilot line equals the outline pressure. If the pilot line pressure is reduced, the diaphragm will move upwards. Consequently the valve will move into an exhaust position relieving the excess air pressure to the atmosphere. This valve is extremely responsive to pilot pressure and can accommodate a very large air flow.

The control valve is constructed entirely with bronze and stainless steel and is ideally suited for all-weather applications.

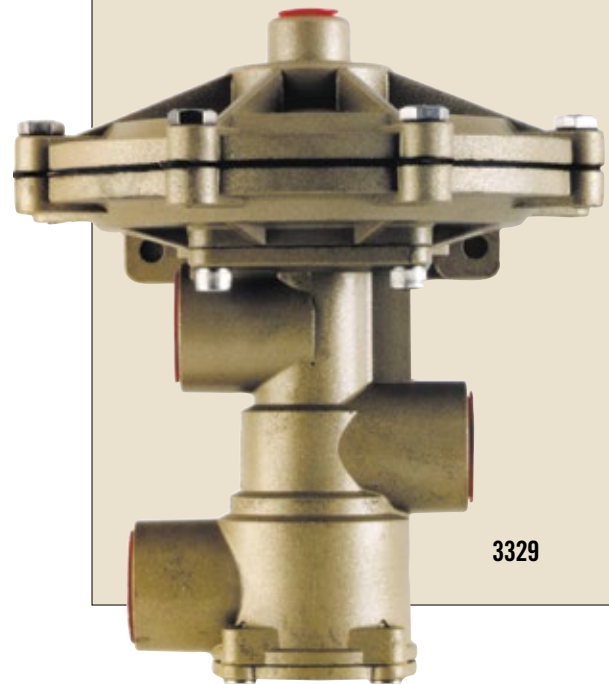

3329

# PNEUMATIC ACCESSORIES

Kobelc is capable of providing all components necessary for a complete control system including all brass and stainless steel quick release valves, shuttle valves, one way check and choke valves and accumulators. Illustrations on this page are only a few of the standard components available from stock.

## SHUTTLE VALVE MODEL 3009

**Weight:** 0.4 lbs (192g) **Material:** Die cast silicon brass and stainless steel  
**Operating Temperature Range:** -40°C to +90°C  
**Pipe Port Size:** 1/4" NPT **Flow Capacity:** 1/4" Orifice Equivalent  
**Maximum Operating Pressure:** 200 PSI (13.8 BAR)

## QUICK RELEASE VALVE MODELS 3903 and 3905

**Weight:** 3903 - 0.9 lbs (428g); 3905 - 1.1 lbs (500g)  
**Materials:** Die cast silicon brass and stainless steel hardware  
**Operating Temperature Range:** -40°C to +90°C  
**Maximum Operating Pressure:** 200 PSI (13.8 BAR)

Pipe Port Size	3903	3905
In & Out Ports	1/4" NPT	1/2" NPT
Exhaust Port	3/8" NPT	1/2" NPT

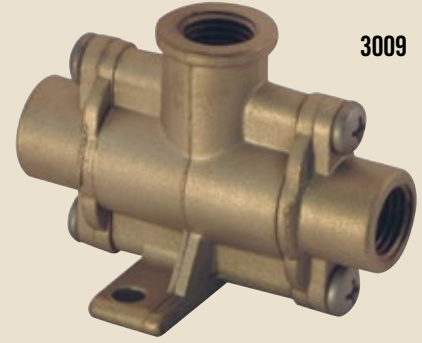

3009



3903

NOTE: Under no circumstances must a shuttle valve be installed with one of the incoming lines plugged.

# RELAY VALVES

- *normally open*, MODELS 3325 and 3328
- *normally closed*, MODELS 3326 and 3327

Kobelc makes a vast variety of relay valves in Normally Open and Normally Closed, and in a single and dual pilot configuration, as well as compensating relays. The purpose of these relays is to interlock control functions and allow for time delays in "ship reversal" without damaging the propulsion machinery. Relays can also be used in the automation of deck machinery to interlock clutches and brakes, etc. Kobelc offers an engineering service to our customers providing system drawings and piping arrangements, as well as specifications for installation. We also assist the ship yard in the installation of our products. This ensures a smooth performance and very few start up problems.

## ORDERING INFORMATION:

Model Designation

- |                                     |                                   |
|-------------------------------------|-----------------------------------|
| A - Standard inlet cap              | DD - Extra light spring 10-20 PSI |
| B - With flow control inlet cap     | E - Left hand model               |
| C - Heavy spring 40-110 PSI         | F - Right hand model              |
| CC - Extra heavy spring 100-160 PSI | H - Piston Operated for oil pilot |
| D - Light spring 25-60 PSI          |                                   |

**Operating Temperature Range:** -40°C to +90°C

**Maximum Supply Pressure:** 200 PSI (13.8 BAR) **Pipe Port Size:** 1/4" NPT



3325



3328

# TIME DELAY & INTERLOCK SYSTEMS

Our engineering department over the last few years has developed the most versatile, robust and non-corrosive timing units (patented). This allows the assembly of an interlocking control system to suit your requirements in very little time. All components are made from brass and stainless steel and carry a two-year warranty. The standard flow capacity is 1/4" diameter and booster relays are available which allows for full flow of 1/2" diameter. Please note that all components on the timing panels are made by Kobelt. Diaphragms, poppets and seats are totally interchangeable from one unit to the next.

The photos at right represent the four basic timing units. Timing systems are available to provide the following functions:

<i>Constant Timing (clutch delay)</i>	<i>Two Stage Charge</i>
<i>Variable Timing (clutch delay)</i>	<i>Pneumatic Slipclutch</i>
<i>Throttle Delay</i>	<i>Over-riding Interlocking Throttle</i>
<i>Throttle Boost</i>	<i>PTO Interlock</i>
<i>Shaftbrake Timing</i>	<i>PTO Speed Limiting</i>
<i>Minimum Timing</i>	

A combination of any of the above functions is available, on pre-assembled timing panels, to suit your requirements.

The following is a short description of the basic control functions:

**Constant Timing:** provides a constant neutral time delay.

**Variable Timing:** provides a variable neutral time delay which is dependent on engine speed and duration of engine speed.

**Minimum Timing:** used in conjunction with variable timing and provides primary constant neutral time delay.

**Throttle Delay:** delays engine acceleration until after the clutches are engaged.

**Throttle Boost:** raises the engine RPM slightly before and during clutch engagement. This is to prevent engine stallout. It is highly recommended on light engines with reduction ratios of 3.5:1 and up.

**Propeller Shaft Disc Brakes:** should be employed on all reduction gear ratios of 5:1 and over. An enormous amount of wear and tear on the engine and gearbox can be eliminated with the application of the Propeller Shaft Brake Timing. The speed of maneuverability is greatly improved. On ships with large reduction gear ratios Throttle Boost and Shaft Brake Timing are employed to prevent engine stallouts.

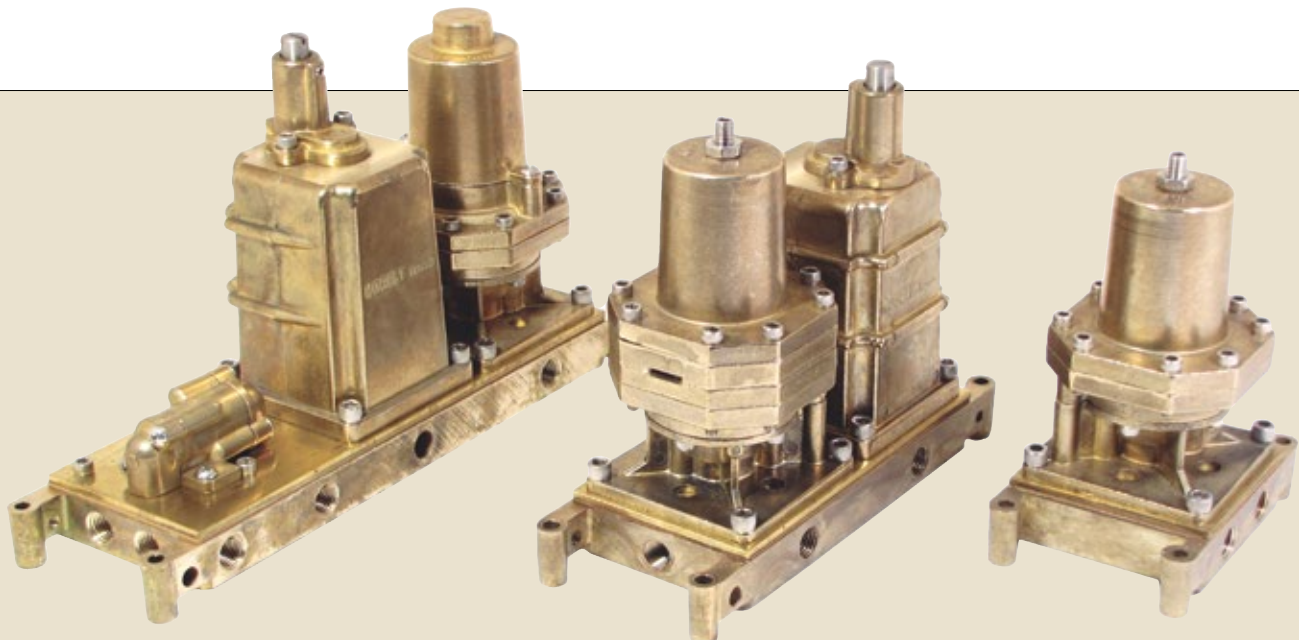

**2850 SERIES (Hydraulic Gear)**

**2870 SERIES (Air Clutches)**

## CONSTANT AND VARIABLE TIMING PANELS

The timing panels illustrated are only two of many standard panels available. Custom made systems are a regular occurrence at Kobelt, and we would be more than pleased to assist you in selecting the right timing system for your requirements. Our interlocking components are also available in cabinets with door-mounted gauges and indicator lights, to suit your needs.

You can be assured that Kobelt timing systems will give you the utmost in performance, engine protection and maneuverability. We are proud to be a forerunner in this area.

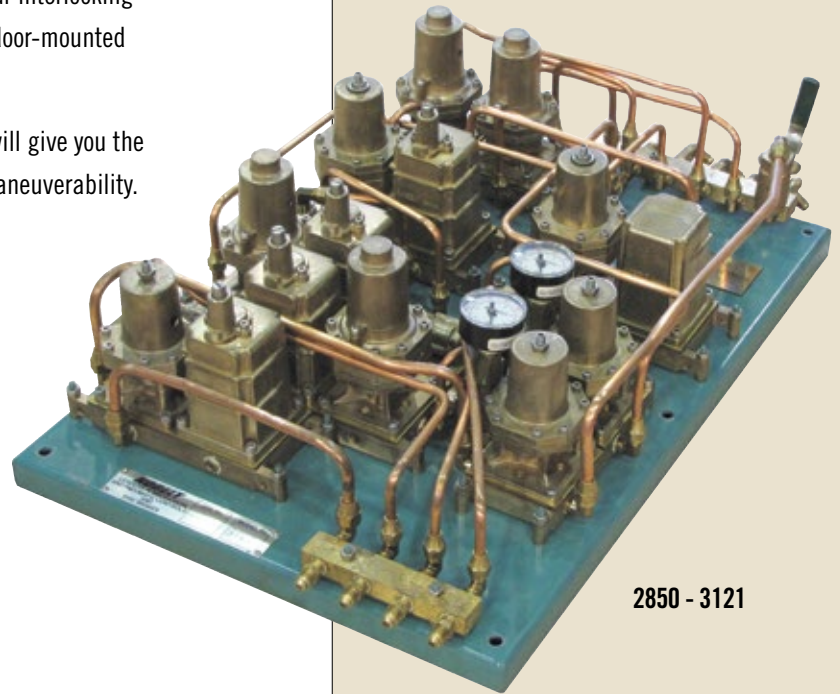

2850 - 3121

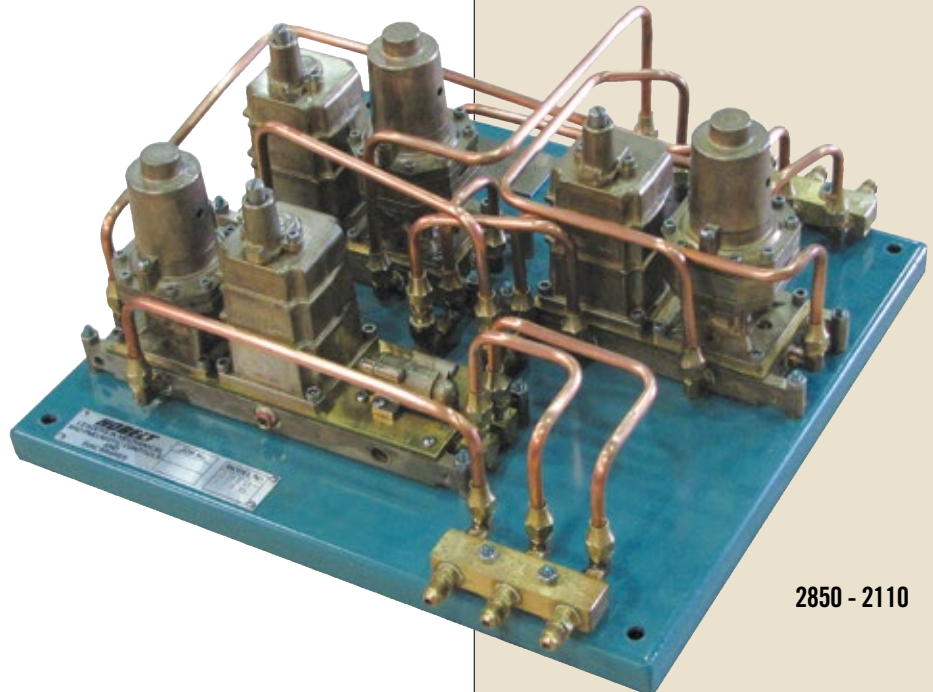

2850 - 2110

# AIR PREPARATION

## Air Treatment Units

In order to provide a satisfactory control system it is of utmost importance to have a reliable source of clean compressed air and storage facilities. Before the air enters the control system an air filter must be provided to remove minor impurities from the air. The filter also removes most of the moisture from the air supply. After the filter, an air pressure regulating valve is required to maintain a specified and constant air pressure. We recommend the installation of a lubricator in the air system which provides an oil fog for the lubrication of all moving parts within the system. See illustration #1.

Illustration #1

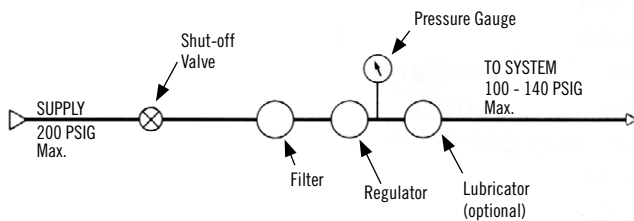

For a more elaborate air treatment unit, dual installations with isolator valves can be installed. See Illustration #2.

A low pressure alarm switch is optionally available to provide a means of warning in the event of loss of air pressure.

Air dryers and antifreeze units are also available upon customer request. These systems are totally flexible and any combination of air preparation units are available to meet specific requirements.

Illustration #2

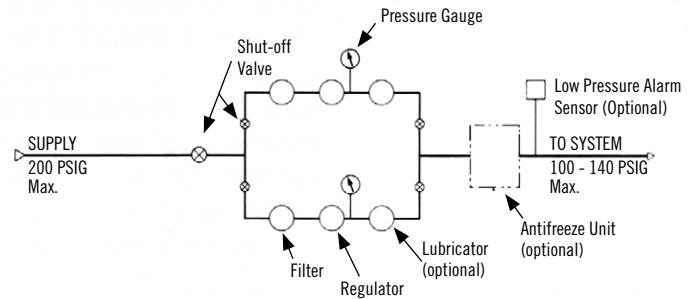

# HIGH PRESSURE REGULATING VALVES

Kobelts does not, at the present time, manufacture low pressure filters, regulators and lubricators. We can, however, supply from stock or your choice of manufacturer any item of this nature.

We manufacture 1" N.P.T. high pressure reducing valves (600 PSI Input) which has been very well accepted in the field.

The valve has full flow capacity and is made from bronze and stainless steel.



# BASIC INSTRUCTIONS

Assisting your marine technicians and engineers in installing and maintaining our controls properly has always been a number one priority at Kobelt. We offer detailed instructions as to how the pneumatic control system works, how best to install a system of this kind and how to best maintain a pneumatic control system. On this page, we can only point out some very basic standards. Should you require any further information please do not hesitate to contact us.

Systems drawings provided by Kobelt will indicate tubing size for various systems. We recommend that these tubing sizes be adhered to as closely as possible since a large tube and long tube acts as a reservoir and could cause a delay in charging

and dumping. On the other hand, too small a tube attached to a valve would cause a restriction in flow volume. One of the most important things to remember during the installation of pneumatic control systems is to keep the tubing and piping system free from foreign matter.

If brackets must be furnished to install our actuators to the engine or gear box, the actuator must be bolted down – do not weld.

Pipe fittings should be installed using a liquid sealant. Teflon tape is not recommended. Fittings must not be over tightened since the tapered thread could in fact cause castings to split.

# STATION, SINGLE ENGINE CLUTCH & THROTTLE CONTROLS

**1 Station**

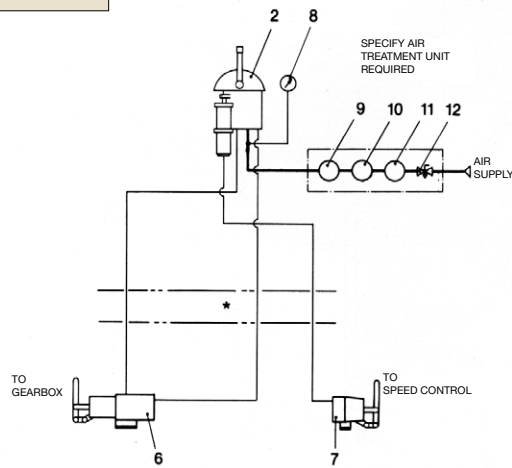

**2 Stations**

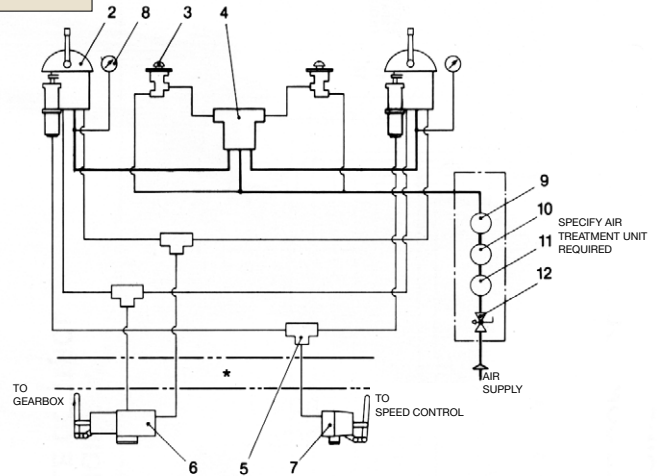

**3 Stations**

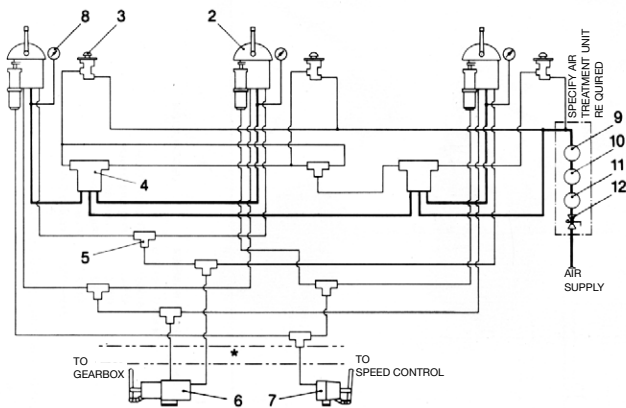

**4 Stations**

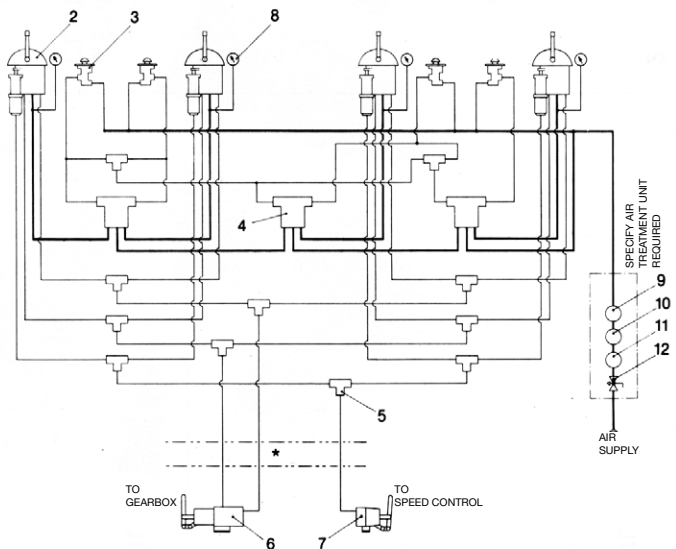

**PARTS LIST**

ITEM	PART NUMBER	DESCRIPTION
1	2545/55	Twin Dual Function Control Head
2	2544/54	Dual Function Control Head
3	3517	2-Pos, 3-Way Palm Valve
4	3403	2-Pos, 4-Way Air Piloted Valve
5	3009	2-Way Check Valve
6	4204-C 4207-C	Clutch Actuator
7	4106-U 4107-U 4108-U	Throttle Actuator
8	82408	Pressure Gauge
9	606-2	Lubricator
10	119-2	Regulator
11	602-2	Filter
12	3150-1050	Vented Ball Valve

**\* NOTE:**

Control systems requiring delays and interlocks must be installed at this point. For Pneumatic Actuated Reverse Gears, interlocks are essential.

# STATION, TWIN ENGINE CLUTCH & THROTTLE CONTROLS

**1 Station**

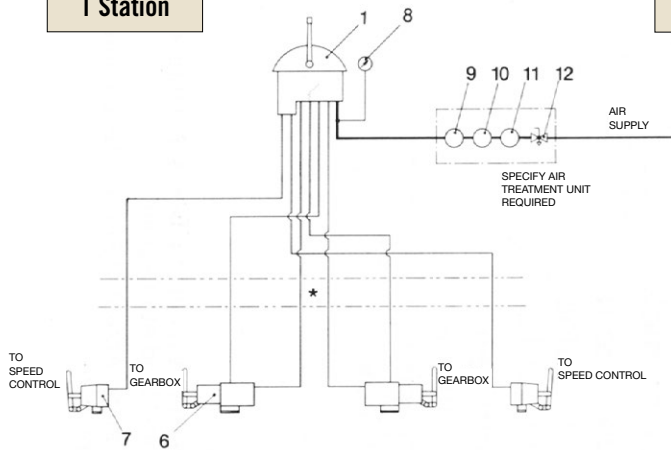

**2 Stations**

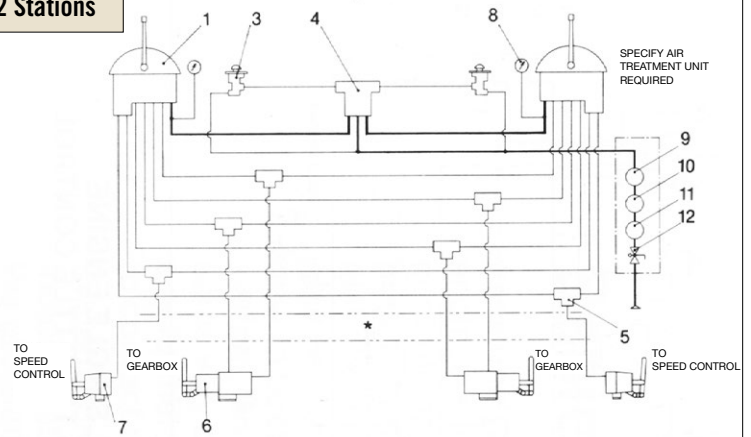

**3 Stations**

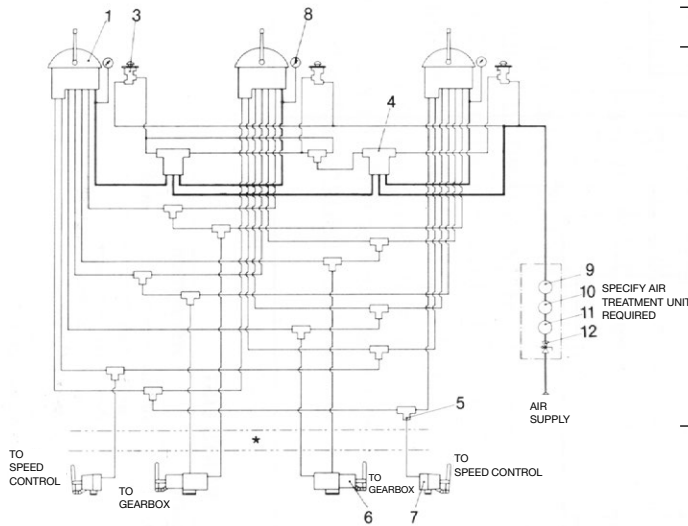

**PARTS LIST**

ITEM	PART NUMBER	DESCRIPTION
1	2545/55	Twin Dual Function Control Head
2	2544/54	Dual Function Control Head
3	3517	2-Pos, 3-Way Palm Valve
4	3403	2-Pos, 4-Way Air Piloted Valve
5	3009	2-Way Check Valve
6	4204-C 4207-C	Clutch Actuator
7	4106-U 4107-U 4108-U	Throttle Actuator
8	82408	Pressure Gauge
9	606-2	Lubricator
10	119-2	Regulator
11	602-2	Filter
12	3150-1050	Vented Ball Valve

**\* NOTE:**

Control systems requiring delays and interlocks must be installed at this point. For pneumatic actuated reverse gears, interlocks are essential.

**4 Stations**

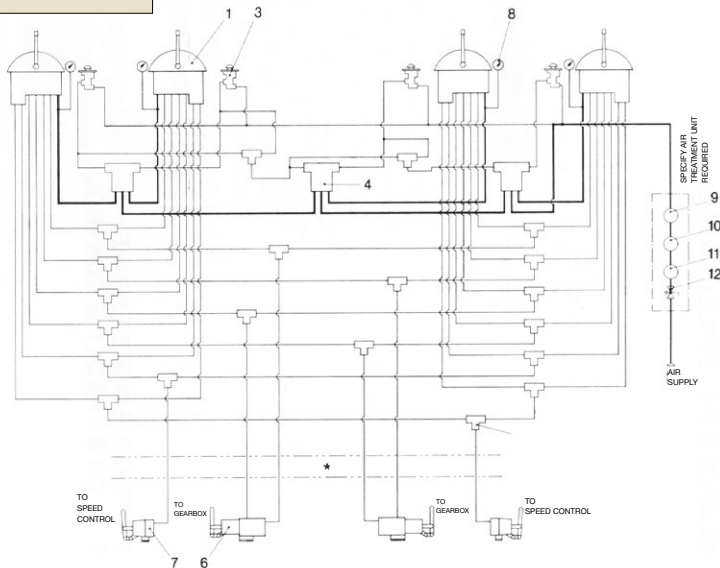



# WINCH AND INDUSTRIAL CONTROLS

Because of the way Kobelt's pneumatic control valves are made, they are ideally suited for damp and salt water environments such as marine winches, mining equipment, wind turbines and innumerable other applications.

Our production includes: 3-way/4-way quick release valves; single, dual and quad compensators for any and all types of applications where an on/off or pressure compensated signal is required.

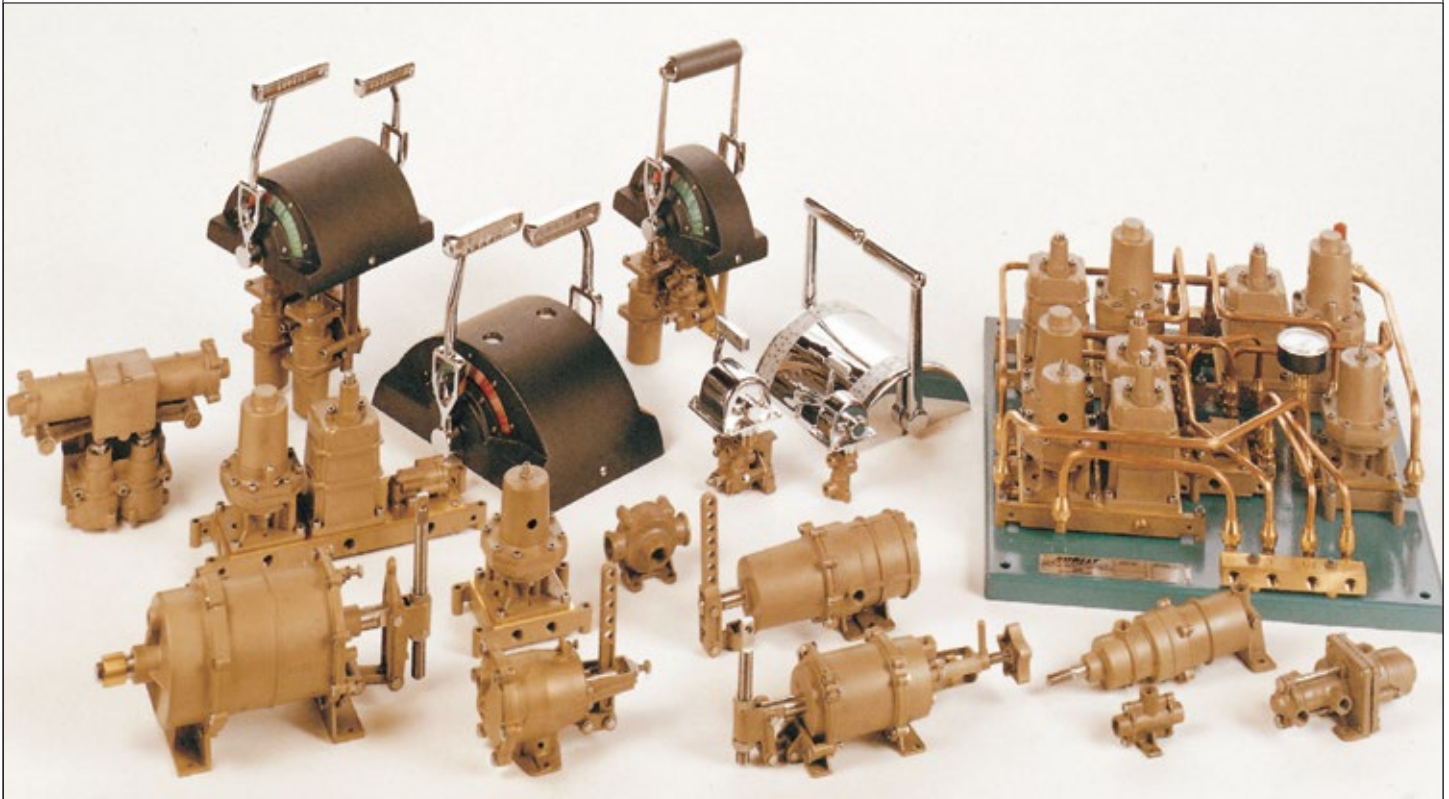

# DISC BRAKES

Kobelc disc brakes are used in all corners of the world. The applications that we serve are limitless. For example, propeller shaft brakes from 40 - 50,000 H.P., supply vessels, and drill ship anchor handling, pipe laying barges, draw work disc brakes both on land and off-shore, conveyor belt systems, chair lifts, cable spooling reels, sugar and paper industry, wind generators, industrial equipment, as well as mining and aerospace.

We offer many patented features which are a direct result of our innovative design and research program. Most of our brake calipers are made from bronze and stainless steel and can be used in almost any kind of environment. The rugged design will offer years of trouble free service. We can also offer several types of brake linings to conform with your environmental controls.

The most recent addition to our ever growing product line is the die-cast brake caliper series. These calipers represent the latest in technology and the absolute utmost in engineering. Their compact design and versatility are unmatched. All castings are made from die-cast silicone bronze with stainless steel hardware, assuring years of trouble free service.

Brake discs are available in many different versions. We can offer solid steel discs, medium duty cast ventilated discs, high energy cast ventilated discs, and supreme duty ventilated and segmented discs, as well as internal water-cooled discs.

Kobelc's disc brakes are manufactured under one or more of the following patent numbers:

U.S. Patent No.	Canadian Patent No.
3722636	895693
3815471	922603
4013148	1069066
4060153	1072025
4108285	1158181
4121697	1176187
4164993	
4236608	
4393962	
4572335	

Further patents pending.

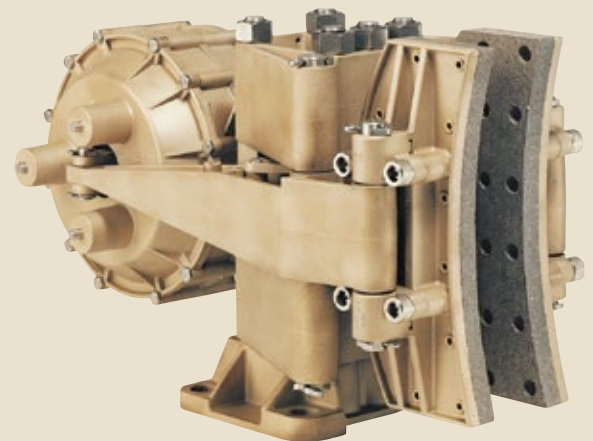
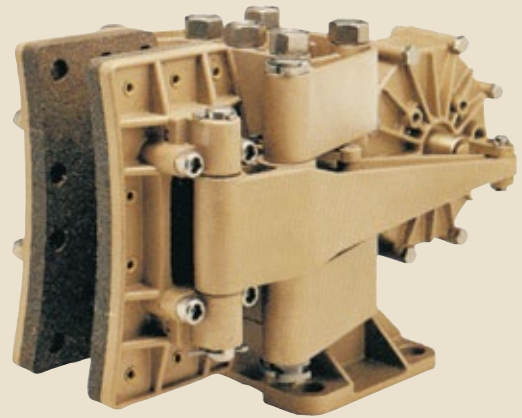
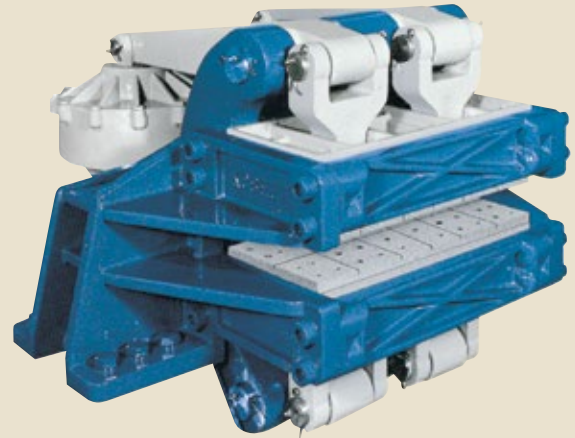



*Kobel Manufacturing, Surrey, British Columbia, Canada*

At Kobelt, we stress the importance of quality, precision, competitive pricing and prompt delivery. Our team of dedicated production staff is uncompromising in ensuring that we meet the needs of all our valued customers. Our growing reputation in world markets is proof of our commitment to highest possible standards.



All Kobelt equipment comes with a 2-year limited warranty that is the best in the industry. Strict quality control manufacturing and sturdy corrosion-resistant materials ensure trouble-free service above and beyond this generous warranty period.

**KOBELT**

8238 129th Street, Surrey  
British Columbia, Canada V3W 0A6  
Sales: 604.590.7313 Fax: 604.590.8313  
sales@kobelt.com www.kobelt.com