

BULLETIN 2332

P-222-28

## Installation Instructions

Overrunning Clutch  
Couplings

Models FW, FWO &  
FWW 403 thru 1018



23601 Hoover Road - Warren, MI 48089-3994 - 586-758-5000

[www.formsprag.com](http://www.formsprag.com)

## Introduction

Formsprag Clutch Couplings combine a Formsprag clutch of either the FSO type or the HPO-High Performance Overrunning type with a Disc Coupling. Follow the step by step installation and maintenance instructions in this bulletin for optimum performance and service life.

## Pre-Installation Check

**⚠ WARNING** Failure to follow these instructions may result in product damage, equipment damage, and serious or fatal injury to personnel.

### FW Series

The FW Series clutch coupling is designed for Inner Race Overrunning. Mount the clutch half of the unit on the driven shaft.

If there are any questions contact Formsprag Application Engineering Department for assistance.

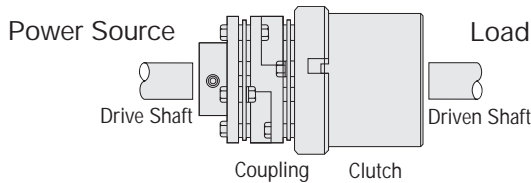

Figure 1

### FWO & FW C/T Series

The FWO and FW C/T Series clutch coupling are designed for Outer Race Overrunning. Mount the clutch half of the unit on the driving shaft.

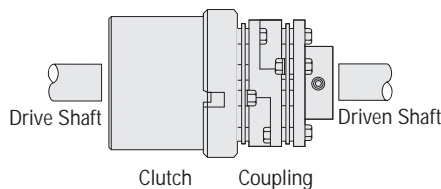

Figure 2

Check the clutch coupling for proper rotation in each application. FW and FWW units are designed for Inner Race overrunning, FWO units for Outer Race overrunning (see Figure 2). Overrunning the wrong race will greatly reduce clutch life. Clutch rotation of FW and FWO units can be changed by removing the clutch adapter and coupling and attaching them to the opposite end of the clutch, which is symmetrical. FWW units should be returned to Formsprag Clutch to change rotation if the stub shaft is retained in the clutch by an interference fit and not an end of shaft bolt. (See Figure 8) In this design the stub shaft is assembled into the clutch inner race with an interference fit and cannot readily be removed without causing damage. If the stub shaft is retained in the clutch (See Figure 7) by the end of the shaft bolt, then the clutch rotation can be changed by unbolting and removing the adapter and removing the clutch from the stub shaft and switching the clutch end for end, as the clutch is symmetrical and reassembling into the stub shaft and attaching the adapter.

### FWW Series

The FWW Series clutch coupling is designed for Inner Race Overrunning. Mount the driving coupling on the driving shaft and the driven coupling on the driven shaft. The clutch and adapter are then mounted with the adapter connected to the driving coupling.

**Note:** Mounting is reversed for C/T Series

If there are any questions contact Formsprag Application Engineering Department for assistance.

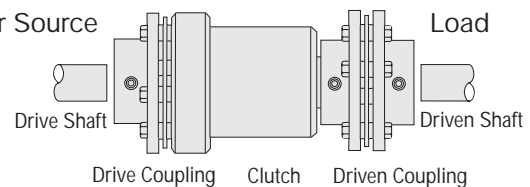

Figure 3

Proper care in installing and aligning will permit clutch couplings to operate to full capacity, compensate for angular misalignment, and provide very good service life.

Shafts may become misaligned as a result of many natural and unavoidable causes. Heat, vibration, bearing wear, setting of foundations, etc., all tend to alter initial alignment. To ensure long life, re-check alignment after a short period of actual running.

In general, clutch coupling life is increased when shafts are initially aligned carefully. If this is not done and a clutch coupling is heavily stressed by torque or other forces, it will have little reserve left with which to accommodate misalignment stresses; and it might not provide the length of service intended. The closer the alignment TIR is to zero, the better the service life of the clutch coupling.

### Installation FW & FWO Series

1. Inspect shafts, clutch bore and coupling hub bore to make sure they are free from burrs.

Check for the proper fit of the keys to the shafts and bores.

### Installing Clutch Portion

Before installing, check:

1. Shaft to Bore fit

Clutch Bore	Shaft Fit Guide*
to 2 inches dia.	line fit to .002" loose
2 to 4 inches dia.	line fit to .0025" loose
4 to 7 inches dia.	line fit to .003" loose

\*If a press fit is necessary under special circumstances, do not exceed .001 inches tight.

In some cases builders of equipment in which a Formsprag clutch is used specify other shaft fit limits than those listed. In this event, direct questions concerning fit limits to the equipment manufacturer.

2. Key and Keyseat

**Hardness:** Use a hardened key, from 30 to 40 Rockwell "C" scale. Use material AISI 1141, 1045 or 4130.

**Length:** The key must be equal to the length of the clutch inner race for proper engagement.

**Fit:** Break edges of the key before installing, to prevent any bearing at these points. Install with a push fit. Be sure the key seats squarely. Do not use a force fit.

3. Check and verify clutch rotation. As described in the pre-installation paragraph.

4. Mount the clutch and key on the shaft.

Apply pressure to end face of the clutch inner race only.

Application of pressure to the outer race could preload the bearings excessively.

5. Secure the clutch in position on the shaft.

Use a flat washer fastened to the shaft end with a screw, snap rings, collars, etc. to keep the clutch in position on the shaft. Fit the clutch/adaptor assembly so that the shaft end is flush with the inner race.

6. For easier mounting, if a .001 inch tight fit is

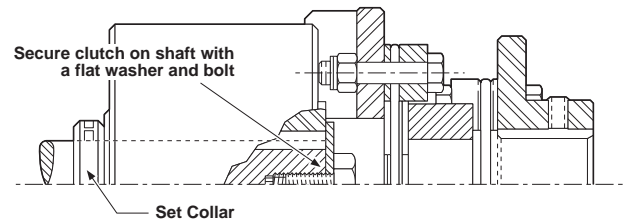

Figure 4

required (tightest allowable), immerse clutch in hot, clean oil (not to exceed 200°F/79°C) for ten or fifteen minutes before mounting.

**Note:** Oil lubricated clutches should be mounted on horizontal shafts only. For vertical shaft mountings contact Formsprag Clutch.

7. Assemble the adapter to the clutch using the bolts provided and tighten the bolts to the values listed in Table V.

If there are any questions contact Formsprag Application Engineering Department for assistance.

## Installation FW & FWO Series Continued

### Installing Coupling Portion

Before installing, check:

1. Inspect shafts and coupling hub bore to make sure they are free from burrs. Check for the proper fit of the keys to the shafts and bores.
2. The rough bor coupling kit is shipped with a coupling hub that will be solid and the face of it is flat. The coupling hub re-bore procedure is as follows:

Check the hub on the barrel diameter and indicate the flange outside diameter to within 0,002 inches and the flange face to within 0.001 inches TIR.

Bore and key to AAGMA tolerances, see Table I.

3. Shaft to bore fit.

**Table I**

#### Standard Bore Tolerances

Nominal Shaft Dia.	Tolerances for Clearance Fit Class-1	Tolerances for Interference Fit**
1/2"	Nominal	Nominal Less .001
thru 1-1/2"	+ .001 - .000	+ .0005 - .0000
over 1-1/2"	Nominal	Nominal Less .002
thru 2"	+ .001 - .000	+ .001 - .000
Over 2"	Nominal	Nominal Less .002
thru 3"	+ .0015 - .0000	+ .001 - .000
Over 3"	Nominal	Nominal Less .003
thru 4"	+ .0015 - .0000	+ .0015 - .0000
Over 4"	Nominal	Nominal Less .003
thru 7"	+ .002 - .000	+ .0015 - .0000

\*\*Unless Otherwise Specified by Customer

4. Fit the coupling hub so that the shaft is flush with the machined face of the hub. Tighten the hub setscrews. If the hub is bored for an interference fit, the hub should be heated in oil @ 200-250°F/79-106°C and then quickly positioned on the shaft. **Do not** spot heat as it may cause distortion.
5. Move the equipment to be connected into position. Set the gap between hub and clutch/adaptor flange to the face to face (F/F) dimensions shown in (Figure 5 and Table III).

### Angular Alignment

1. After preliminary alignment, secure a dial indicator to one flange and indicate face of the other flange near its outer diameter.
2. Rotate the member to which the indicator is attached to find minimum indicator reading. Set the indicator for zero reading. (See Table II.)
3. Again, rotate the member (with indicator attached) 360° to check misalignment.
4. Adjust position of connected equipment until indicator reading is within the allowable variation shown in the table.

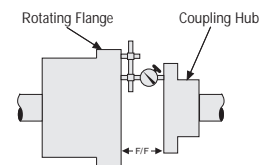

#### Angular Alignment

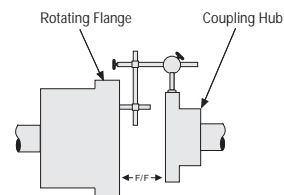

#### Parallel Alignment

**Figure 5**

### Parallel Alignment

1. Reposition indicator and check for parallel alignment. Adjust height of connected equipment to attain minimum misalignment (See Table II.)
2. Recheck angular alignment to make certain it has not changed.

### Assembly

1. Install the flex packs, washers and spacer block assembly per Figure 6. Do not force bolts into holes.

**Important:** To ensure long life re-check alignment after a short period (one to two hours) of actual running. At this time also re-torque bolts and nuts to values in Table IV.

## Models FW & FWO

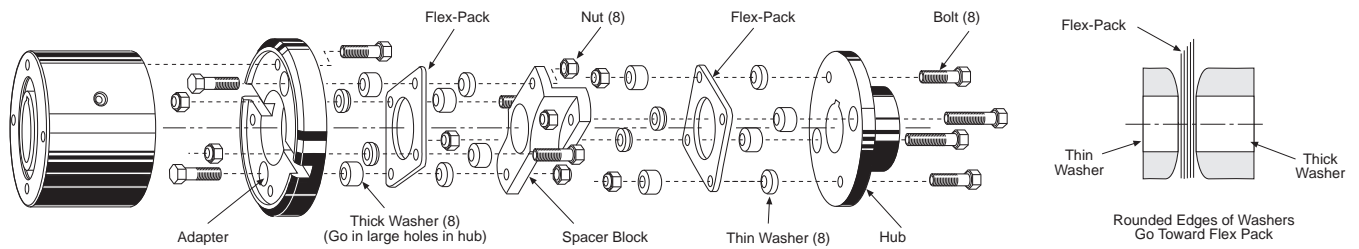

Figure 6

## Installation FWW Series

Before installing, check:

1. Inspect shafts and coupling hub bore to make sure they are free from burrs. Check for proper fit of the keys to the shafts and bores.
2. The rough bore coupling kit is shipped with a coupling hub that will be solid and the face of it is flat. The coupling hub re-bore procedure is as follows:

Chuck the hub on the barrel diameter and indicate the flange outside diameter to within 0.002 inches and the flange face to within 0.001 inches TIR.

Bore and key to AGMA tolerances, see Table I.

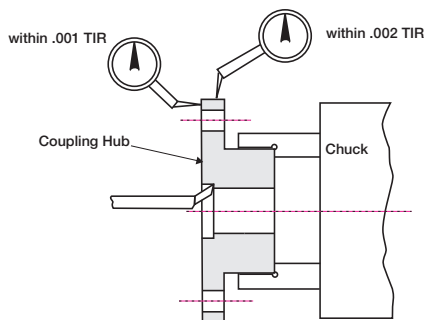
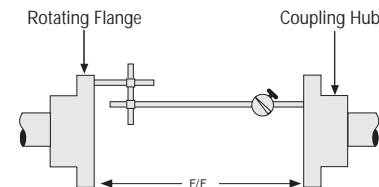

Figure 7

3. Shaft to bore fit, see Table I.
4. Fit each coupling hub so that the shaft is flush with the machined face of the flange. Tighten the hub setscrews. If the hub is bored for an interference fit, the hub should be heated in oil @ 200-250°F/79-106°C and then quickly positioned on the shaft. **Do not** spot heat as it may cause distortion. (See fits in Table I.)
5. Move the equipment to be connected into position. Set the gap between hub flanges to the face to face (F/F) dimensions shown in (Table III and Figure 8).

## Angular Alignment

1. After preliminary alignment, secure a dial indicator to one flange and indicate face of the other flange. (See Figure 8 and Table II.)
2. Rotate the member to which the indicator is attached to find minimum indicator reading. Set the indicator for zero reading.
3. Again, rotate the member (with indicator attached) 360° to check misalignment.
4. Adjust position of connected equipment until indicator reading is within the allowable variation shown in the table.



Angular Alignment

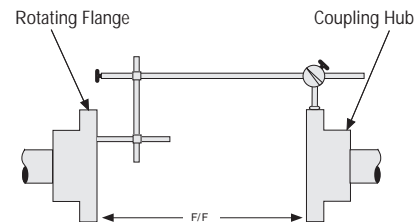

Parallel Alignment

Figure 8

## Parallel Alignment

1. Reposition indicator and check for parallel alignment. Adjust height of connected equipment to attain minimum misalignment. (See Figure 8 and Table II.)
2. Recheck angular alignment to make certain it has not changed.
3. Check for proper installation by overrunning (free-wheeling) the clutch by hand. (See Figure 3.)

## Assembly

1. Determine clutch rotation as described ~~ss~~ **described in the pre-installation paragraph** as proper rotation in each application is extremely important. With the clutch rotation established assemble the clutch onto the stub shaft and secure with washer and bolt, tighten to values listed in Table VI. Use a strap wrench on the stub shaft flange OD to react the installation torque applied to the clutch retention bolt.

**Note:** Oil lubricated clutches should be mounted on horizontal shafts only. For vertical shaft mountings contact Formsprag Clutch.

2. Assemble the adapter to the clutch using the bolts provided and tighten the bolts to the values listed in Table V.
3. Install the clutch assembly and blades as shown in Figures 3 and 9.

**Note:** Mounting is reversed for C/T series, since the outer race overruns.

**Important:** To ensure long life re-check alignment after a short period (one to two hours) of actual running. At this time also re-torque bolts and nuts to values in (Table IV).

If there are any questions contact Formsprag Application Engineering Department for assistance.

# Model FWW

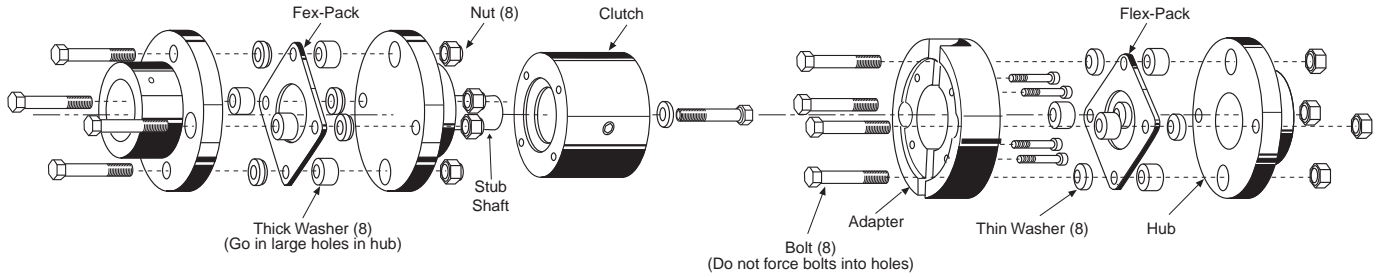

Figure 9

**Table II – Total Indicator Reading, Maximum; Inches**

Model	403	406	420	504	508	530	607	610	640	708	712	728	732	745	752	754	755	812	814	916	1018
T.I.R.* Angular	0.028	0.036	0.036	0.036	0.048	0.048	0.042	0.068	0.058	0.050	0.068	0.050	0.068	0.058	0.068	0.080	0.080	0.068	0.080	0.062	0.062
T.I.R.* Parallel	0.006	0.006	0.021	0.006	0.008	0.029	0.009	0.015	0.030	0.012	0.015	0.012	0.015	0.039	0.015	0.017	0.048	0.015	0.017	0.029	0.029

**Table III – Face to Face (F/F) Dimensions; Inches**

Model	403	406	420	504	508	530	607	610	640	708	712	728	732	745	752	754	755	812	814	916	1018
FW, FWO, FWW																					
Face to Face	1.44	1.40	5.31	1.40	2.01	7.16	2.24	3.63	7.44	3.11	3.63	3.11	3.63	9.72	3.63	4.21	12.05	3.63	4.21	7.13	7.13
Min. Dimension																					
Axial ±	0.012	0.012	0.012	0.012	0.012	0.012	0.012	0.012	0.012	0.012	0.012	0.012	0.012	0.012	0.012	0.012	0.012	0.012	0.012	0.012	0.012

**Table IV – Coupling Bolt Installation Torque (lb. ft.)\*\*\***

Model	403	406	420	504	508	530	607	610	640	708	712	728	732	745	752	754	755	812	814	916	1018
Bolt Torque	8	19	19	19	66	66	37	236	111	111	236	111	236	236	236	465	465	236	465	554	554

**Table V – Adapter Bolt Installation Torque (lb. ft.)\*\*\***

Model	403	406	420	504	508	530	607	610	640	708	712	728	732	745	752	754	755	812	814	916	1018
Adapter Bolt																					
Torque	21	21	21	21	21	21	21	21	21	39	39	39	39	39	92	92	92	92	92	186	186
Stub Shaft																					
Bolt Torque	-	-	9	-	-	37	-	-	83	-	-	-	-	292	-	-	327	-	-	-	-

\* This is the maximum allowable change in dimensions F/F for clutch couplings in the stretched or compressed condition

**NOTE:** If the installation requires a "stretched" F/F dimension to allow for shaft growth due to heat, do not exceed F/F plus ±\* at cold installation.

\*\*\* Torque values are based upon lubricated threads.

**NOTE:** Assembly of the Flex-Pack may be difficult due to the bolt diameters that are a tight fit into the Flex-Pack holes.



# Lubrication Maintenance

## Oil lubrication

1. Use oils selected from the following table according to the application and ambient temperature existing at the clutch.
2. Check oil level monthly.
3. Add oil if necessary to maintain one-half full level. Use oil specified. Do not use substitutes.

Temperature Range	Recommended Lubricant
+20°F to +150°F (-7°C to +65°C) (Max. permissible ambient temperature)	Chevron GST Oil 68 Mobil DTE Heavy Medium Any Automatic Transmission Fluid (ATF) Texaco Regal Oil R&O 68 Shell Turbo Oil 68 AMOCO Industrial Oil 68 Exxon Teresstic Oil 68 Sunoco Sunvis 931
-10°F to +20°F (-23°C to -7°C)	Chevron GST Oil 46 Mobil Gargoyle Arctic C Heavy Texaco Regal Oil R&O 46 Any Automatic Transmission Fluid (ATF) AMOCO Industrial Oil 46 Sunoco Sunvis 921
-40°F to +150°F (-40°C to +65°C) (Max. permissible ambient temperature)	Mobil Jet Oil 2 Shell Turbine Oil 500 Exxon Turbo Oil 2389 Standard Esso Turbo Oil 2389 Military Oils MIL-L-7808 or MIL-L-23699

**⚠ CAUTION** Do not use lubricants containing slippery additives, or those having extreme pressure characteristics such as any EP type lubricants. For additional Lube information, see Brochure #A-4032.

**⚠ WARNING** The use of lubricants in clutch assemblies, other than those shown, can result in improper sprag engagement. Improper sprag engagement may cause personal injury or property damage.

Formsprag is not responsible for any changes made by the manufacturers in their lubricants.

The use of any lubricants, other than those listed in this bulletin, will automatically void any warranty.

4. To assure continued efficiency of operation, flush clutch every six months with mineral spirits.
5. Flush with mineral spirits and relubricate before use if clutch has been stored or out of use for six months or more. Flushing will remove waxes or gums formed by vaporization of the oil.

## Grease Lubrication

1. Use greases selected from the following table according to the application and ambient temperature existing at the clutch. For temperatures below +20°F/-6°C, consult Formsprag Clutch.
2. Pump grease into clutch with grease gun until fresh grease flows freely from around the seals at both ends of the clutch. (Seals have been installed to allow purging of old grease.)

Allowable greases for ALL clutch couplings EXCEPT FWO-728 thru FWO-1018. (See Chart below.)

Temperature Range	Recommended Lubricant
+20°F to +150°F (-6°C to +66°C) (permissible ambient temperature)	Fiske Bros. "Lubriplate Low-Temp" Fiske Bros. "Aero Lubriplate" Shell "Aeroshell No. 7" Shell Aeroshell No. 16 Mobil Exxon Beacon 325

Allowable greases for models FWO-728 thru FWO-1018. (See Chart below.)

Temperature Range	Recommended Lubricant
+20°F to +150°F (-6°C to +66°C) (permissible ambient temperature)	Fiske Bros. "Aero Lubriplate"



## **Clutch Rebuilding Service**

**Disassembly and repair of Formsprag clutches in the field is not recommended.**

Formsprag clutches are precision devices manufactured under careful controls to meet exacting standards. When reconditioning is required, clutches should be returned to Formsprag Clutch directly, through the Distributor, or through the Original Equipment Manufacturer.

## **Rotating Equipment**

Rotating equipment is potentially dangerous and should be properly guarded. The user should check for all applicable safety codes (in local area) and provide a suitable guard.

For Application Assistance call 1-800-927-3262.

## Warranty

Formsprag LLC warrants that it will repair or replace (whichever in its sole discretion it deems advisable) any product it manufactured and sold which proves to be defective in material or workmanship within a period of one (1) year from date of original purchase for consumer, commercial or industrial use. This warranty extends only to the original purchaser and is not transferable or assignable without Formsprag LLC's prior consent.

This warranty covers normal use and does not cover damage or defect which results from alterations, accident, neglect, disassembly, or improper installation, operation, or maintenance.

Formsprag LLC's obligation under this warranty is limited to the repair or replacement of the defective product. In no event shall Formsprag LLC be liable for consequential, indirect or incidental damages of any kind incurred by reason of manufacture, sale or use of any defective product. Formsprag LLC neither assumes nor authorizes any other person to give any other warranty or to assume any other obligation or liability on its behalf.



Formsprag Clutch  
23601 Hoover Road • Warren, MI 48089  
586-758-5000 • Fax: 586-758-5204